

WD8704EJ(A/F/G/H/S/V/W/Z)
WD8702EJ(A/F/G/H/S/V/W/Z)
WD8700EJ(A/F/G/H/S/V/W/Z)
WD8704RJ(A/F/G/H/S/V/W/Z)
WD8702RJ(A/F/G/H/S/V/W/Z)
WD8700RJ(A/F/G/H/S/V/W/Z)
WD8704CJ(A/F/G/H/S/V/W/Z)
WD8702CJ(A/F/G/H/S/V/W/Z)
WD8700CJ(A/F/G/H/S/V/W/Z)
WD8704DJ(A/F/G/H/S/V/W/Z)
WD8702DJ(A/F/G/H/S/V/W/Z)
WD8700DJ(A/F/G/H/S/V/W/Z)

Washing Machine

user manual

QUELLAVELINGE.COM

imagine the possibilities

Thank you for purchasing this Samsung product.
To receive more complete service, please register
your product at

www.samsung.com/register



features of your new samsung washing machine

Your new washing machine will change the way you feel about doing laundry. From its super-size capacity to its energy efficiency, the Samsung washing machine has all the features to turn a mundane chore into a pleasure.

- **Washing to drying with one button**

Enjoy convenient non stop washing and drying managing. 4 different special drying programs can be selected to perform the whole wash cycle including the drying cycle using one button.

- Cupboard(standard program), Low temp drying, Iron, Time Drying (30min ~ 270mins)
Those drying programs also can be operated independently of washing programs.

- **Child Lock**

The Child Lock function ensures that curious little hands are kept out of your washing machine.

This safety feature stops your children from playing with the operation of the washing machine, and alerts you when it is activated.

- **Wool Certified**

The machine has been tested and passed the required Woolmark Company specification for machine washable wool products.

Fabrics should be washed according to the instructions on the garment label as specified by Woolmark and Samsung.

- **Delay End**

Delay a cycle for up to 19 hours in one-hour increments and increase the convenience of using your washing machine especially when you have to go out.

- **Quick Wash**

No time to lose! Less than 30 minutes wash will give you time to run out before it's too late.

Our 29 minute Quick Wash program can be the solution to your busy life. Now you can wash your favourite clothes in only 29 minutes!

- **Delicates & Hand Wash Program**

Special care can be determined by the appropriate temperature, the gentle wash action and the appropriate amount of water.

- **Ceramic Heater for Durability & Energy Saving (selected models)**

Our truly innovative Ceramic Heater is twice as durable as regular heaters.

That saves you money on repairs. Plus, it eliminates the scale of hard water and save energy.

- **Air Wash**

The Air Wash system deodorizes unpleasant smells and sterilizes the laundry that cannot be eliminated through a conventional washing system, a benefit of its unique air-washing mechanism.

- Air-washable : Woolen coats, cotton/down jumpers, sweaters, suits, pillows, cushions, needlework dolls
- Not applicable : leather, silk, velvet, electric blankets, other stained laundry

- **Digital Graphic Display**

The Digital Graphic Display control panel is clear and easy to use for minimum fuss and hassle. And while it is easy to operate, the Digital Graphic Display enables you to make quick and accurate adjustments to your wash for excellent washing results.

- **Wide door**

Extra wide door aperture for convenient viewing! Easily add and remove laundry, especially for large sized laundry items such as bedding, towels etc.

- **Direct Drive Motor**

As the drum does not utilize belts or gears, vibrations are reduced significantly. This feature ensures that your washer machine is quieter and more durable.

This manual contains important information on the installation, use, and care of your new Samsung washing machine. Refer to it for descriptions of the control panel, instructions on how to use the washing machine, and tips for making the most of its state-of-the-art features and functions. The “**Troubleshooting and information codes**” section on page 29 tells you what to do if something goes wrong with your new washing machine.











QUELLAVELLEDIGITAL.COM

safety information

Throughout this manual, you'll see Warning ⚠ and Caution ⚠ notes. These warnings, cautions, and the important safety instructions that follow do not cover all possible conditions and situations that may occur. It's your responsibility to use common sense, caution, and care when installing, maintaining, and operating your washing machine. Samsung is not liable for damages resulting from improper use.

IMPORTANT SAFETY SYMBOLS AND PRECAUTIONS

What the icons and signs in this user manual mean:

 WARNING	Hazards or unsafe practices that may result in severe personal injury or death.
 CAUTION	Hazards or unsafe practices that may result in minor personal injury or property damage.
 CAUTION	To reduce the risk of fire, explosion, electric shock, or personal injury when using your washing machine, follow these basic safety precautions:
	Do NOT attempt.
	Do NOT disassemble.
	Do NOT touch.
	Follow directions explicitly.
	Unplug the power plug from the wall socket.
	Make sure the machine is grounded to prevent electric shock.
	Call the service center for help.
	Notice

These warning signs are here to prevent injury to you and others.

Please follow them explicitly.

After reading this section, keep it in a safe place for future reference.

-  Read all instructions before using the appliance.

As with any equipment using electricity and moving parts, potential hazards exist. To safely operate this appliance, become familiar with its operation and exercise care when using it.

Install and store your washing machine inside, away from exposure to weather.

Install and level your washing machine on a floor that can support its weight.

-  Your washing machine must be properly grounded. Never plug it into an ungrounded outlet.



To reduce the risk of fire or explosion:

- Do not wash items that have been washed, soaked, or treated with gasoline, dry cleaning solvents, or other flammable or explosive substances. They give off vapors that could ignite or explode. Rinse by hand any material that has been exposed to cleaning solvent or other flammable liquids or solids before putting in your washing machine. Be sure that all traces of such liquids, solids, and fumes have been removed. Dangerous substances include acetone, denatured alcohol, gasoline, kerosene, certain liquid household cleaners and spot removers, turpentine, waxes, and wax removers.
- Do not put gasoline, dry cleaning solvents, or other flammable or explosive substances into the washing machine.
- Under certain conditions, hydrogen gas may be produced in a hot water system—such as your hot water heater -- that has not been used for two weeks or more. **HYDROGEN GAS IS EXPLOSIVE.** If your hot water system has not been used for two weeks or more, turn on all hot water taps in your home, and let the water flow for several minutes before using your washing machine. This will release any hydrogen gas build-up. Since hydrogen gas is flammable, do not smoke or light an open flame during this time.

Ventilate immediately without touching the power plug if there is a gas leak.



Unplug the power cord before servicing your washing machine.

Before each wash, empty the pockets of your laundry. Small, irregularly shaped hard objects, such as coins, knives, pins, and paperclips could damage your washing machine. Do not wash clothing with large buckles, buttons, or other heavy metal metal.

Do not open the door of the washing machine if you can still see water. Check that the water has drained before opening the door.



Do not repair, replace, or service any part of your washing machine yourself unless you fully understand the recommended user-repair instructions and have the skills to carry them out. Work done by an unauthorized person may void your warranty.

Connect the washing machine to the water mains using the new set of hoses. Do not reuse the old set of hoses.

Water inlet hoses deteriorate over time. Check the hoses periodically for bulges, kinks, cuts, wear, and leaks, and replace them as needed and at least every five years.

All packaging and shipping bolts must be removed before the appliance is used. Serious damage may occur if they are not removed. See page 12 "Removing the shipping bolts".



Before washing clothes for the first time, you must run a complete cycle without clothes. See "Washing for the first time".

safety information

The appliance is designed for home use only.



Make sure that water and electrical connections are made by qualified technicians, observing the user manual (see “Installing your washing machine”) and local safety regulations.



Before cleaning or carrying out maintenance, unplug the appliance from the electrical outlet.

Always unplug the appliance and turn off the water after use.

Make sure that the pockets of all clothing to be washed are empty.

Hard, sharp objects, such as coins, safety pins, nails, screws, or stones can cause extensive damage to the appliance.

Never allow pets and children to play on or in the appliance. It may cause injury or suffocate them.

The glass door becomes very hot during the washing cycle. Never touch on the glass door while it is in use.



Do not attempt to repair the appliance yourself. Repairs made by inexperienced or unqualified persons may cause injury and/or make more serious repairs to the appliance necessary.

If the plug (power supply cord) is damaged, it must be replaced by the manufacturer or its service agent or a similarly qualified person in order to avoid a hazard.

This appliance should only be serviced by our authorized service center, and only rated spare parts should be used.



Do not let children (or pets) play on or in your washing machine. The washing machine door does not open easily from the inside, and children may be seriously injured if trapped inside.



This appliance is not intended for use by persons (including children) with reduced physical, sensory or mental capabilities, or lack of experience and knowledge, unless they have been given supervision or instruction concerning use of the appliance by a person responsible for their safety.

Children should be supervised to ensure that they do not play with the appliance

To use this appliance safely, the user should become familiar with the instructions for operation of the appliance and always take extra care when using it.

This appliance should be positioned to be accessible to the power plug, the water supply taps and the drain pipes.



Packing materials can be dangerous to children; keep all packing material (plastic bags, polystyrene, etc.) well out of the reach of children.

Do not use processed water containing oil, cream or lotion, which is usually found in skincare shops or massage clinics.

- Otherwise this will cause the packing to be deformed, which causes a malfunction or water leak.

A stainless washing tub does not usually rust. However if some metal such as a hair pin is left in the tub for an extended time, the tub could rust.

- Do not leave water or bleach containing chlorine in the tub for an extended period of time.
- Do not regularly use or leave water containing iron in the tub for an extended period of time. If rust starts appearing on the surface of the tub, apply a cleansing agent (neutral) to the surface and use a sponge or soft cloth to clean it. (Under no circumstances use a metal brush)

The dryer is not to be used if chemicals have been used for cleaning.

For washing machines with ventilation openings in the base, ensure that the opening is not obstructed by carpet or any other obstacles.

Use the new hose-sets and old hose-sets should not be reused.

QUELLAVELINGE.COM

contents

SETTING UP YOUR WASHING MACHINE	9	Checking the parts
	10	Meeting installation requirements
	10	Electrical supply and grounding
	10	Water Supply
	11	Drain
	11	Flooring
	11	Surrounding temperature
	11	Alcove or closet installation
	11	Installing your washing machine
WASHING A LOAD OF LAUNDRY	17	Washing for the first time
	17	Basic instructions
	18	Using the control panel
	20	Child lock
	20	Sound off
	20	Delay end
	20	Drain Only Function
	21	Air Wash
	22	USING DRY COURSE
	23	Washing clothes using the cycle selector
	23	Washing clothes manually
	24	LAUNDRY GUIDELINES
	25	Detergent and additives information
	25	Which detergent to use
	25	Detergent drawer
CLEANING AND MAINTAINING YOUR WASHING MACHINE	26	Draining the washing machine in an emergency
	26	Cleaning the exterior
	27	Cleaning the detergent drawer and drawer recess
	27	Cleaning the debris filter
	28	Cleaning the water hose mesh filter
	28	Repairing a frozen washing machine
	28	Storing your washing machine
TROUBLESHOOTING AND INFORMATION CODES	29	Check these points if your washing machine...
	30	Information codes
CYCLE CHART	31	Cycle chart
APPENDIX	32	Fabric care chart
	32	Protecting the environment
	32	Declaration of conformity

setting up your washing machine

Be sure to have your installer follow these instructions closely so that your new washing machine works properly and so that you're not at risk of injury when doing laundry.

CHECKING THE PARTS

Carefully unpack your washing machine, and make sure you've received all of the parts shown below. If your washing machine was damaged during shipping, or if you do not have all of the parts, contact Samsung Customer Service or your Samsung dealer.

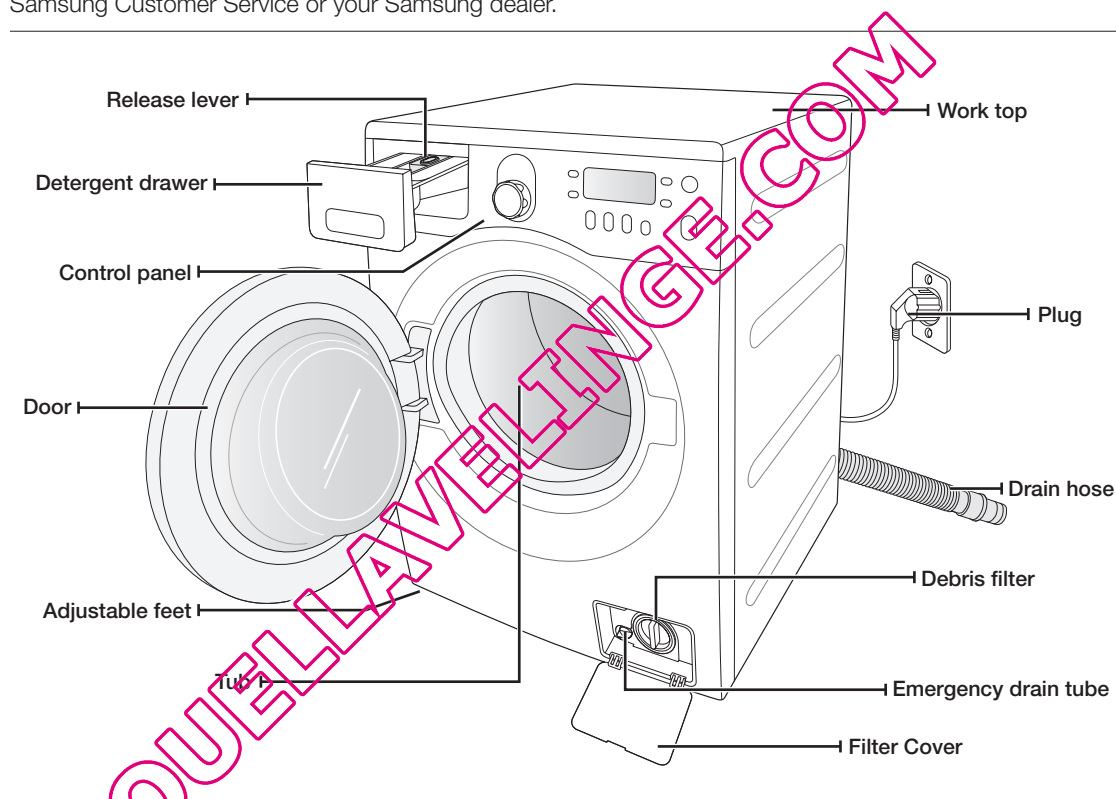

Spanner

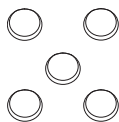

Bolt hole covers



Water supply hose

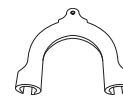

Hose guide

setting up your washing machine

MEETING INSTALLATION REQUIREMENTS

Electrical supply and grounding

To prevent unnecessary risk of fire, electrical shock, or personal injury, all wiring and grounding must be done in accordance with the National Electrical Code ANSI/FNPA, No. 70 Latest Revision and local codes and ordinances. It is the personal responsibility of the appliance owner to provide adequate electrical service for this appliance.

 Never use an extension cord.
WARNING Use only the power cord that comes with your washing machine.

When preparing for installation, ensure that your power supply offers:

- 220V~240V 50Hz 15 AMP fuse or circuit breaker
- Individual branch circuit serving only your washing machine

Your washing machine must be grounded. If your washing machine malfunctions or breaks down, grounding will reduce the risk of electric shock by providing a path of least resistance for the electric current.

Your washing machine comes with a power cord having a three-prong grounding plug for use in a properly installed and grounded outlet.

 Never connect the ground wire to plastic plumbing lines, gas lines, or hot water pipes.

Improperly connecting the equipment-grounding conductor can result electrical shock. Check with a qualified electrician or serviceman if you are unsure if the washing machine is properly grounded. Do not modify the plug provided with the washing machine. If it does not fit the outlet, have a proper outlet installed by a qualified electrician.

Water Supply

Your washing machine will fill properly when your water pressure is 50 kPa ~ 800 kPa. Water pressure less than 50 kPa may cause water valve failure, not allowing the water valve to shut off completely. Or, it may take the washing machine longer to fill than what the controls allow, resulting in your washing machine turning off. (A fill-time limit, designed to prevent overflows/flooding if an internal hose becomes loose, is built into the controls.)

The water taps must be within 4 feet (122cm) of the back of your washing machine for the provided inlet hoses provided to reach your washing machine.

 Most plumbing supply stores sell inlet hoses of various lengths up to 10 feet (305cm) long.

You can reduce the risk of leaks and water damage by:

- Making water taps easily accessible.
- Turning off taps when the washing machine is not in use.
- Periodically checking for leaks at water inlet hose fittings.

 Before using your washing machine for the first time, check all connections at the water valve and taps for leaks.

Drain

Samsung recommends a standpipe height of 18 in (46 cm). The drain hose must be routed through the drain hose clip to the standpipe. The standpipe must be large enough to accept the outside diameter of the drain hose. The drain hose is attached at the factory.

Flooring

For best performance, your washing machine must be installed on a solidly constructed floor. Wood floors may need to be reinforced to minimize vibration and/or unbalanced loads. Carpeting and soft tile surfaces are contributing factors to vibrations and the tendency for your washing machine to move slightly during the spin cycle.

Never install your washing machine on a platform or poorly supported structure.

Surrounding temperature

Do not install your washing machine in areas where water may freeze, since your washing machine always retains some water in its water valve, pump, and hose areas. Frozen water in the lines can cause damage to belts, the pump, and other components.

Alcove or closet installation

To operate safely and properly, your new washing machine requires minimum clearances of:

Sides – 25 mm

Rear – 51 mm

Top – 25 mm

Front – 465 mm

If both the washing machine and a dryer are installed together, the front of the alcove or closet must have at least 465 mm unobstructed air opening. Your washing machine alone does not require a specific air opening.

INSTALLING YOUR WASHING MACHINE

STEP 1

Selecting a location

-  Before you install the washing machine, make sure the location:
- Has a hard, level surface without carpeting or flooring that may obstruct ventilation
 - Is away from direct sunlight
 - Has adequate ventilation
 - Will not be freezing (below 32 °F or 0 °C)
 - Is away from heat sources such as oil or gas
 - Has enough space so that the washing machine doesn't stand on its power cord

setting up your washing machine

STEP 2

Removing the shipping bolts

Before installing the washing machine, you must remove the five shipping bolts from the back of the unit.

1. Loosen all the bolts with the supplied wrench.

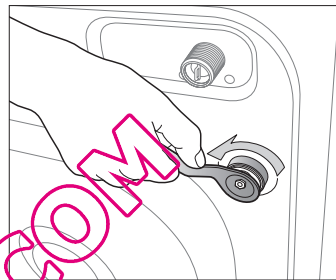

2. Hold the bolt with the spanner and pull it through the wide section of the hole. Repeat for each bolt.

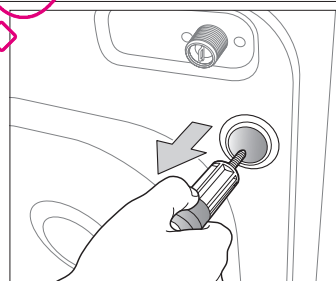

3. Fill the holes with the supplied plastic covers.

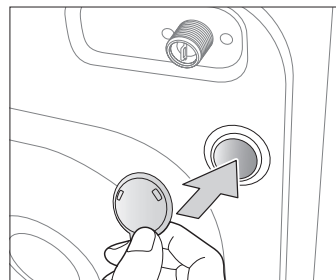

4. Store the shipping bolts away safely in case you have to move the washing machine in the future.



WARNING Packaging materials can be dangerous to children; keep all packaging material (plastic bags, polystyrene, etc.) well out of the reach of children.

STEP 3**Adjusting the levelling feet**

 When installing your washing machine, ensure that the power plug, the water supply and the drain are easily accessible.

1. Slide the washing machine into position.

2. Level your washing machine by turning the leveling feet in and out as necessary by hand.

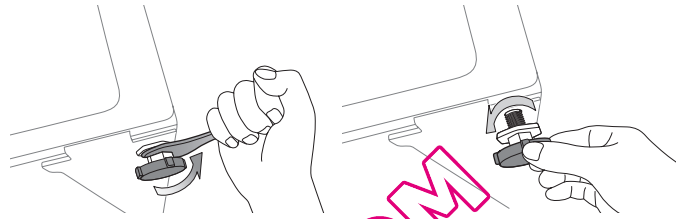

3. When your washing machine is level, tighten the nuts using the wrench supplied with your washing machine.

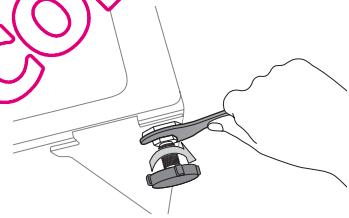
**STEP 4****Connecting the water and drain****Connecting the water supply hose**

1. Take the L-shaped arm fitting for the cold water supply hose and connect it to the cold water supply intake on the back of the machine. Tighten by hand.

 The water supply hose must be connected to the washing machine at one end and to the water tap at the other. Do not stretch the water supply hose. If the hose is too short, replace the hose with a longer, high pressure hose.

2. Connect the other end of the cold water supply hose to your sink's cold water tap and tighten it by hand. If necessary, you can reposition the water supply hose at the washing machine end by loosening the fitting, rotating the hose, and retightening the fitting.

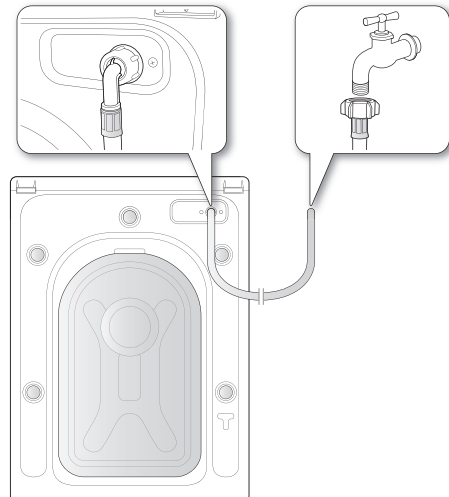
**For selected models with an additional hot water intake:**

1. Take the red L-shaped arm fitting for the hot water supply hose and connect it to the hot water supply intake on the back of the machine. Tighten by hand.

2. Connect the other end of the hot water supply hose to your sink's hot water tap and tighten it by hand.

3. Use a Y-piece if you only want to use cold water.

setting up your washing machine

Connecting the water supply hose (selected models)

1. Remove the adaptor from the water supply hose.

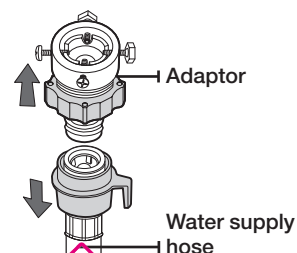

2. First, using a '+' type screwdriver, loosen the four screws on the adaptor. Next, take the adaptor and turn part (2) following the arrow until there is a 5 mm gap.

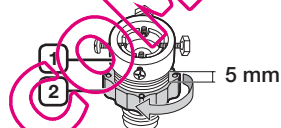

3. Connect the adaptor to the water tap by tightening the screws firmly while lifting the adaptor upwards. Turn part (2) following the arrow and connect (1) and (2).

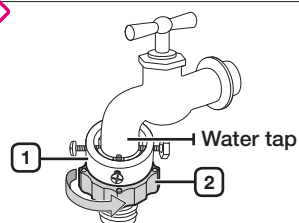

4. Connect the water supply hose to the adaptor. When you release part (3), the hose automatically connects to the adaptor making a 'click' sound.

 After you have connected the water supply hose to the adaptor, ensure that it is connected correctly by pulling the water supply hose downwards.

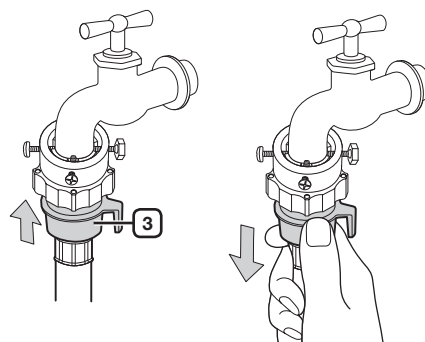

5. Connect the other end of the water supply hose to the inlet water valve at the rear of the washing machine. Screw the hose clockwise all the way in.

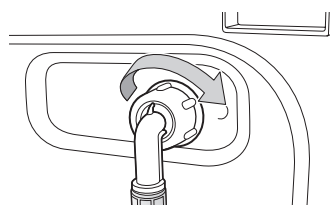

6. Turn on the water supply and ensure that no water leaks from the water valve, tap or adaptor. If there is a water leak, repeat the previous steps.

 **WARNING** Do not use your washing machine if there is a water leak. This may cause electric shock or injury.

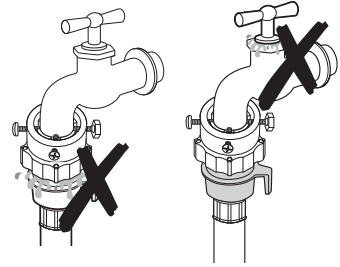

- If the water tap has a screw type tap, connect the water supply hose to the tap as shown.

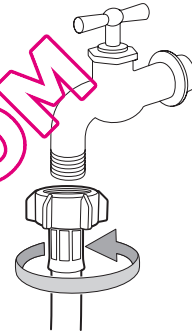

- Use the most conventional type of tap for the water supply. In case the tap is square or too big, remove the spacing ring before inserting the tap into the adaptor.

setting up your washing machine

Connecting the drain hose

The end of the drain hose can be positioned in three ways:

1. **Over the edge of a wash basin:** The drain hose must be placed at a height of between 60 and 90 cm. To keep the drain hose spout bent, use the supplied plastic hose guide. Secure the guide to the wall with a hook or to the tap with a piece of string to prevent the drain hose from moving.

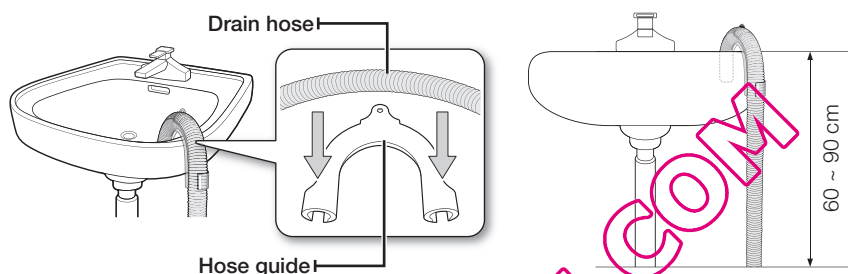

2. **In a sink drain pipe branch:** The drain pipe branch must be above the sink siphon so that the end of the hose is at least 60 cm above the ground.
3. **In a drain pipe:** We recommend using a 65 cm high vertical pipe; it must be no shorter than 60 cm and no longer than 90 cm.

STEP 5

Powering your washing machine

Plug the power cord into a wall socket, a 230 volt 50 Hz approved electrical outlet protected by a 15-amp fuse or comparable circuit breaker. (For more information on electrical and grounding requirements, see page 10.)

washing a load of laundry

With your new Samsung washing machine, the hardest part of doing laundry will be deciding which load to wash first.

WASHING FOR THE FIRST TIME

 Before washing laundry for the first time, you must run a complete empty cycle (i.e. no laundry).

1. Press the **Power** button.
2. Add a little detergent to the detergent compartment ① in the detergent drawer.
3. Turn on the water supply to the washing machine.
4. Press the **Start/Pause** button.

 This will remove any water that might be left over in the machine from the manufacturer's test run.

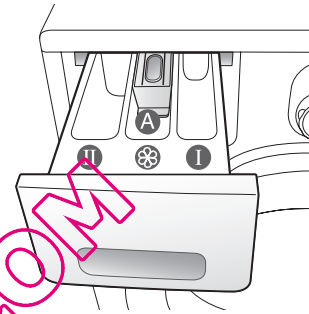

Compartment ①: Detergent for prewash, or starch.

Compartment ②: Detergent for the main wash, water softener, pre-soaking agent, bleach and stain removal product.

Compartment ③: Additives, e.g. fabric softener or former (fill no higher than lower edge (MAX) of "A")

BASIC INSTRUCTIONS

1. Load your laundry into the washing machine.

 **WARNING** Do not overload the washing machine. To determine the load capacity for each type of laundry, refer to the chart on page 24.



-  • Make sure that laundry is not caught in the door, as this may cause a water leak.
- Washing detergent may remain in the front rubber part of the washer after a wash cycle. Remove any remaining detergent, as they may cause a water leak.
- Do not wash water-proofed items.





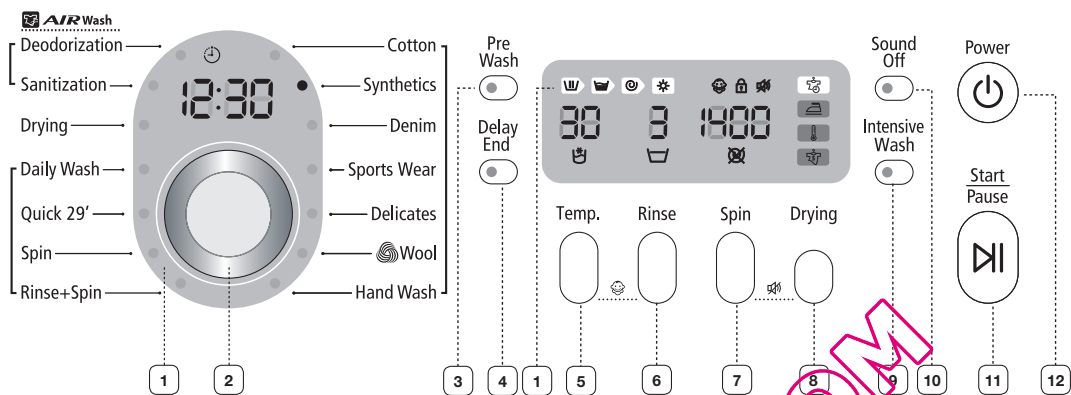















2. Close the door until it latches.
3. Turn the power on.
4. Add detergent and additives to the dispenser drawer.
5. Select the appropriate cycle and options for the load.
The Wash Indicator light will illuminate and the estimated cycle time will appear in the display.
6. Press the **Start/Pause** button.

washing a load of laundry

USING THE CONTROL PANEL



<p>1 DIGITAL GRAPHIC DISPLAY</p>	<p>Displays the remaining wash cycle time, all cycle information, and error messages.</p>
<p>2 CYCLE SELECTOR</p>	<p>Select the tumble pattern and spin speed for the cycle.</p> <p> For detailed information, refer to "Washing clothes using the cycle selector". (see page 23)</p> <p>Cotton - For averagely or lightly soiled cottons, bed linen, table linen, underwear, towels, shirts, etc.</p> <p>Synthetics - For averagely or lightly soiled blouses, shirts, etc., made of polyester (diolen, trevira), polyamide (perlon, nylon) or other similar blends.</p> <p>Denim - A higher water level in the main wash and extra rinse ensure that no washing powder remains that may mark your clothing.</p> <p>Sports Wear - Use for water-proofed or proofed garments to keep their good looks and fresh feel.</p> <p>Delicates - For sheer fabrics, brassieres, lingerie, dresses, shirts and blouses. For best results, use liquid detergent.</p> <p>Wool - Only for machine-washable wool. A load should be less than 2.0 kg.</p> <ul style="list-style-type: none"> The wool course washes the laundry using gentle cradling actions. During the wash, the gentle cradling and soaking actions are continued to protect the wool fibers from shrinkage / distortion and for a super gentle clean. This stop operation is not a problem. Neutral detergent is recommended for wool course, for improved washing results and for improved care of the wool fibers. <p> The wool wash cycle of this machine has been approved by Woolmark for the washing of machine-washable Woolmark products provided that the products are washed according to the instructions on the garment label and those issued by the manufacturer of this washing machine, M0509 (Certificate Number issued by IWS NOM INEE Co., Ltd.)</p> <p>Handwash - A very light wash cycle as gentle as a hand wash.</p> <p>Air Wash - This course is useful for removing bad odors. Turning the Cycle Selector cycles through the following operating modes. (Deodorization → Sanitization)</p> <ul style="list-style-type: none"> Deodorization - Reduces bad smells from the laundry Sanitization - Deodorize and sterilize the laundry by stronger air wash action with higher temp. <p>Drying - Select to dry laundry automatically by detecting the amount and weight of the laundry.</p>

	<p>Daily Wash - Use for everyday items such as underwear and shirts.</p> <p>Quick 29' - For lightly soiled garments that you require quickly.</p> <p>Spin - Performs an additional spin cycle to remove more water.</p> <p>Rinse + Spin - Use for a load that needs rinsing only or to add rinse-added fabric softener to a load.</p> <p>Drain Only - Turn the Cycle Selector to the Spin position, press the Spin button, and then press the Start/Pause button to drain the water.</p>						
3	<p>PREWASH SELECTION BUTTON</p> <p>Press this button to select pre-wash. Pre-wash is only available with: Cotton, Synthetics, Denim, Sports Wear, Daily Wash.</p>						
4	<p>DELAY END SELECTION BUTTON</p> <p>Press this button repeatedly to cycle through the available Delay End options (from 3 hours to 19 hours in one hour increments). The hour displayed indicates the time when the wash cycle will be finished.</p>						
5	<p>TEMPERATURE SELECTION BUTTON</p> <p>Press this button repeatedly to cycle through the available water temperature options: (Cold Water , 30 °C, 40 °C, 60 °C and 95 °C).</p>						
6	<p>RINSE SELECTION BUTTON</p> <p>Press this button to add additional rinse cycles. The maximum number of rinse cycles is five.</p>						
7	<p>Press the button repeatedly to cycle through the available speeds for the spin cycle.</p> <table border="1"> <tr> <td>WD8704</td> <td> 400, 800, 1200, 1400 rpm</td> </tr> <tr> <td>WD8702</td> <td> 400, 800, 1000, 1200 rpm</td> </tr> <tr> <td>WD8700</td> <td> 400, 600, 800, 1000 rpm</td> </tr> </table> <p>“No spin ” - The laundry remains in the drum and no spin cycle is performed after the final drain.</p> <p>“Rinse Hold ” - The laundry remains soaking in the final rinse water. Before the laundry can be unloaded, either a Drain or Spin cycle must be performed.</p>	WD8704	 400, 800, 1200, 1400 rpm	WD8702	 400, 800, 1000, 1200 rpm	WD8700	 400, 600, 800, 1000 rpm
WD8704	 400, 800, 1200, 1400 rpm						
WD8702	 400, 800, 1000, 1200 rpm						
WD8700	 400, 600, 800, 1000 rpm						
8	<p>Pressing the button cycles through the following options.</p> <p>Cup Board  → Low Temp  → Iron  → Time Dry  (30min. → 1:00min. → 1:30min. → 2:00min. → 2:30min. → 3:00min. → 3:30min. → 4:00min. → 4:30min.) → Cup Board</p> <p>“Cup Board ” - Use this cycle to dry loads such as cotton, underwear, and linen.</p> <p>“Low Temp ” - This cycle protect heat-sensitive items at a low drying temperature.</p> <p>“Iron ” - Finishes the dry cycle in a moist state appropriate for Ironing.</p> <p>“Time Dry ” -Dry the laundry for the specified period of time.</p> <p> • You must avoid washing laundry that may not be dried as it may be deformed even at low temperatures.</p> <ul style="list-style-type: none"> • The Cup Board, Low Temp, Iron and Time Dry options detect the weight of the laundry in order to display an accurate drying time and dry them more completely. • The drying conditions may differ depending on the type and the amount of laundry. 						
9	<p>INTENSIVE WASH SELECTION BUTTON</p> <p>Press this button when the laundry is heavily soiled and needs to be washed intensively. The cycle time is increased for each cycle.</p>						
10	<p>SOUND OFF BUTTON</p> <p>The sound can be turned off for all courses. When this function is selected, the sound is turned off for all cycles.</p> <ul style="list-style-type: none"> • When the Sound off function is activated, the lamp on the Sound Off button and the control panel are illuminated. • When the Sound off function is deactivated, a buzzer will go off, and the lamp on the button and the control panel is turned off. 						
11	<p>START/PAUSE SELECTION BUTTON</p> <p>Press to pause and restart a cycle.</p>						

washing a load of laundry

12 POWER BUTTON

Press it once to turn your washing machine on, press it again to turn your washing machine off. If the washing machine is left on for more than 10 minutes without any buttons being touched, the power automatically turns off.

Child lock

The Child Lock function allows you to lock the buttons so that the wash cycle you've chosen can't be changed.

Activating/Deactivating

If you want to activate or deactivate the Child Lock function, press the **Temp.** and **Rinse** buttons at the same time for 3 seconds. "Child Lock" will be lit when this feature is activated.

- When the Child Lock function is activated, only the **Power** button works. The Child Lock function remains on even after the power is turned on and off or after the disconnecting and reconnecting the power cord.

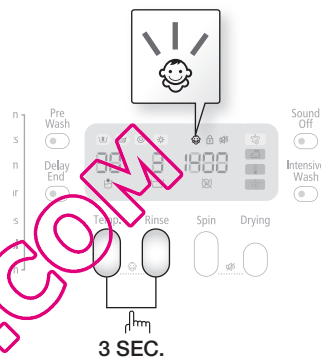

Sound off

The Sound Off function can be selected during all courses. When this function is selected, sound is turned off for all courses. Even if the power is turned on and off repeatedly, the setting is retained.

Activating/Deactivating

If you want to activate or deactivate the Sound Off function, press the **Sound OFF** button. The lamp on the **Sound Off** button and the control panel will be lit when this feature is activated.

Delay end

You can set the washing machine to finish your wash automatically at a later time, choosing a delay of between 3 to 19 hours (in 1 hour increments). The hour displayed indicates the time at which the wash will be finished.

- Manually or automatically set your washing machine according to the type of laundry you are washing.
- Press the **Delay End** button repeatedly until the delay time is set.
- Press the **Start/Pause** button. The "Delay End" indicator will be lit, and the clock will begin counting down until it reaches the set time.
- To cancel a Delay End function, press the **Power** button and then turn the washing machine on again.

Drain Only Function

When you want just drain water from washing machine, follow directions below.

- Press the **Power** button
- Turn the Cycle Selector to the Spin position.
- Press the **Spin** button 1 times until rpm sign is off.
- Then "1" shows up on time display in center.
- Press the **Start/Pause** button.

Air Wash

Air Wash can refresh laundry without using water owing to its powerful airing system. Clothing that can be refreshed includes woolen coats, cotton or jumpers, sweaters and suits. (Two items or less (less than 1 kg))

1. Open the door, place the laundry into the washing machine and close the door.
2. Press the **Power** button.
3. Select **Air Wash** by turning the **Cycle Selector**.
 - Each time the button is pressed, the operating mode cycles through the following sequence: Deodorization, Sanitization ...

MODE	CYCLE TIME
Deodorization	29 min
Sanitization	59 min

- When one of these options has been selected, no other button can be selected and you can only select the delay end time from between 3:00 – 19:00.
4. Close the door and press the **Start/Pause** button.
 - When there is water in the tub, **Air Wash** cannot be selected. Drain the water and select **Air Wash**.
 - Press the **Start/Pause** or **Power** button to remove the laundry.
 - Fragrance or dryer sheets can be used with Air Wash programs to add fragrance to your refreshed laundry (one sheet per one or two items).

- Avoid Air Wash the following clothes:
 - Sensitive clothes made of leather, mink, fur, silk, etc.
 - Underwear trimmed with lace, 'glued' doll cushions, and dress suits may have their decorations loosened.
 - Clothes trimmed with buttons can cause them to break.
 - Starchy clothes can become deformed.
 - Hard bedding such as a wooden pillows (neck-rest)
 - Pillows or blankets filled with plastic or starch rather than cotton
 - Electric blankets
 - Furry blankets
 - Bulky blankets
 - Latex pillow

washing a load of laundry

USING DRY COURSE

Refer to the label of drying capacity and be sure to put in the clothes to the lower level than the marked line for the dried clothe of 5.0kg.

1. Open the door, put in the clothes and close the door again.
2. Press the **Power** button and then press the **Drying** button.
: The standard course will be selected automatically.
Drying is available only at the courses such as cotton, synthetics, denim and sports wear.
3. Select **Drying** button as follows.

Drying Programs

- Every press of this button will select drying type repeatedly in the following order:
Cup Board (☞) → **Low Temp** (⏴) → **Iron** (☞) → **Time Dry** (☞) (30min. → 1:00min. → 1:30min. → 2:00min. → 2:30min. → 3:00min. → 3:30min. → 4:00min. → 4:30min.) → **Cup Board**

Drying Type		Information	Time (Max Load)
Auto Drying	Cupboard(☞)	Standard: Dries the laundry.	160min.
	Low Temp.(⏴)	Dries the laundry at a low temperature to protect the texture of the laundry.	160min.
	Iron(☞)	For leaving items partially damp so that it can be easily ironed	30min.
Time Drying(☞)		You can select the appropriate drying time depending on the texture, quantity, and moisture.	270min.

- It automatically displays Drying Time by sensing the weight of clothes before drying for increasing the drying effect.
 - For laundry weighing less than 3.5kg, use the Auto Dry. For laundry that weighs more, please use the Time Dry.
 - If both the spin and drying cycles are selected, the spin speed is automatically selected to enhance the drying efficiency.
 - When using the drying cycle, check if the water supply valve is opened.
4. Put suitable amount of detergent and fiber softener in the detergent tray and close it again.
 5. Press **Start/Pause** button.
: It automatically performs an optimal function from washing to drying.
 - The selected course can't be altered after the start of drying.
 - If you select Drying function, the intensity of SPIN will be set up as High in default for increasing the drying effect.
 - If cold water is not supplied, drying will not be performed.
 - If you do not take out clothes from the tub after the end of drying, a function of wrinkle protection will be performed for about 30 minutes with the display of [End]. In order to take out the clothes: press firstly Start/Pause or Power button and take them out.
 - In case you wish to dry after hand washing, select both Spin and Dry at the same time.

Washing clothes using the cycle selector

Your new washing machine makes washing clothes easy, using Samsung's "Fuzzy Control" automatic control system. When you select a wash program, the machine will set the correct temperature, washing time, and washing speed.

1. Turn on your sink's water tap.
 2. Press the **Power** button.
 3. Open the door.
 4. Load the articles one at a time loosely into the drum, without overfilling it.
 5. Close the door.
 6. Add detergent, softener, and pre-wash detergent (if necessary) into the appropriate compartments.
-  Pre-wash is only available when selecting the Cotton, Synthetics, Denim, Sports Wear, and Daily Wash cycles. It is only necessary if your clothing is heavily soiled.
7. Use the **Cycle Selector** to select the appropriate cycle according to the type of material: Cotton, Synthetics, Denim, Sports Wear, Delicates, Wool, Hand Wash, Daily Wash, Quick 29'. The relevant indicators will illuminate on the control panel.
 8. At this time, you can control the wash temperature, the amount of rinses, the spinning speed, and the delay time by pressing the appropriate option button.
 9. Press the **Start/Pause** button and the wash will begin. The process indicator will light up and the remaining time for the cycle will appear in the display.

Pause Option

Within 5 minutes of starting a wash, it is possible to add/remove laundry items.

1. Press the **Start/Pause** button to unlock the door.
-  The door cannot be opened when the water is too HOT or the water level is too HIGH.
2. After closing the door, press the **Start/Pause** button to restart the wash.

When the cycle is finished:

After the total cycle has finished, the power will turn off automatically.

1. Open the door.
2. Remove laundry.

Washing clothes manually

You can wash clothes manually without using the Cycle Selector.

1. Turn the water supply on.
2. Press the **Power** button on the washing machine.
3. Open the door.
4. Load the articles loosely into the drum one at a time, without overfilling it.
5. Close the door.
6. Add detergent and, if necessary, softener or prewash detergent, into the appropriate compartments.
7. Press the **Temp.** button to select the temperature. (Cold water, 30 °C, 40 °C, 60 °C, 95 °C)
8. Press the **Rinse** button to select the required number of rinse cycles.
The maximum number of rinse cycles is five.
The wash duration is increased accordingly.
9. Press the **Spin** button to select the spin speed.
The rinse hold function allows you to remove items that are still wet from the washing machine. (☒ : No Spin, ☐ : Rinse Hold)
10. Press the **Delay End** button repeatedly to cycle through the available Delay End options (from 3 hour to 19 hours in one hour increments). The hour displayed indicates the time at which the wash will be finished.
11. Press the **Start/Pause** button and the machine will begin the cycle.

washing a load of laundry

LAUNDRY GUIDELINES

Follow these simple guidelines for the cleanest laundry and the most efficient wash.

 Always check the Care label on clothing before washing.

Sort and wash your laundry according to the following criteria:

- Care Label: Sort laundry into cottons, mixed fibres, synthetics, silks, wools and rayons.
- Colour: Divide whites and colours. Wash new colour items separately.
- Size: Placing items of different sizes in the same load will improve the wash action.
- Sensitivity: Wash delicate items separately, using the Delicate wash cycle for pure, new woollen items, curtains and silk articles. Check the labels on the items you are washing or refer to the fabric care chart in the appendix.

Emptying pockets

Before each wash, empty all the pockets of your laundry. Small, irregularly shaped hard objects, such as coins, knives, pins, and paperclips could damage your washing machine. Do not wash clothing with large buckles, buttons, or other heavy metal objects.

Metal on clothing may damage your clothing as well as the tub. Turn clothing with buttons and embroidered clothes inside out before washing them. If zips of pants and jackets are open while washing, the spin basket may be damaged. Zips should be closed and fixed with a string before washing.

Clothing with long strings may become entangled with other clothes damaging them. Be sure to fix the strings before starting the wash.

Prewashing cotton

Your new washing machine, combined with modern detergents, will give perfect washing results, thus saving energy, time, water and detergent. However, if your cotton is particularly dirty, prewash with a protein-based detergent.

 **Make sure to insert brassieres (water washable) into a laundry net (to be purchased additionally).**

- The metal parts of the brassieres may break through the material and damage the laundry. Therefore make sure to place them inside a fine laundry net.
- Small, light clothing such as socks, gloves, stockings and handkerchiefs may become caught around the door. Place them inside a fine laundry net.

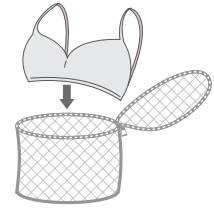

Do not wash the laundry net by itself without other laundry. This may cause abnormal vibrations that could move the washing machine and cause an accident resulting in injury.

DETERGENT AND ADDITIVES INFORMATION

Which detergent to use

The type of detergent you should use is based on the type of fabric (cotton, synthetic, delicate items, wool), colour, wash temperature, and degree of soiling. Always use "low suds" laundry detergent, which is designed for automatic washing machines.

Follow the detergent manufacturer's recommendations based on the weight of the laundry, the degree of soiling, and the hardness of the water in your area. If you do not know how hard your water is, enquire at your local water authority.



Do not use detergent that has hardened or solidified as the detergent may remain in the rinse cycle. It may cause your washing machine to not rinse properly or result in the overflow becoming blocked.



Please note the following when using the wool course.

- Use a neutral liquid detergent for wool only.
- When using a powder detergent, it may remain on the laundry and cause damage to the material (wool).

Detergent drawer

Your washing machine has separate compartments for dispensing detergent and fabric softener. Add all laundry additives to the correct compartment before starting your washing machine.



Do NOT open the detergent drawer when your washing machine is running.

1. Pull out the detergent drawer on the left side of the control panel
2. Add the recommended amount of laundry detergent directly into the detergent compartment ① before starting your washing machine.
3. Add the recommended amount of fabric softener into the softener compartment ② if required.
4. When using the Prewash option, add the recommended amount of laundry detergent into the prewash compartment ③.



When washing large items do NOT use the following detergent types.

- Tablet and capsule type detergents
- Detergents using a ball and net



Concentrated or thick fabric softener and conditioner must be diluted with a little water before being poured into the dispenser (prevents the overflow from becoming blocked.)

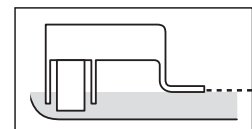
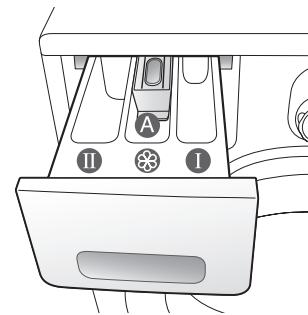

MAX

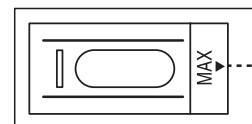

MAX

cleaning and maintaining your washing machine

Keeping your washing machine clean improves its performance, wards off unnecessary repairs, and lengthens its life.

DRAINING THE WASHING MACHINE IN AN EMERGENCY

1. Unplug the washing machine from the power supply.
2. Open the filter cover using a coin or a key.

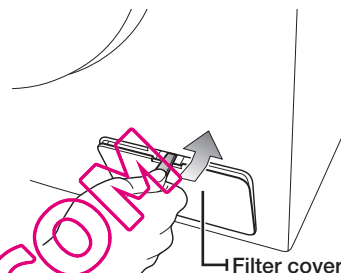

3. Unscrew the emergency drain cap by turning it to the left.

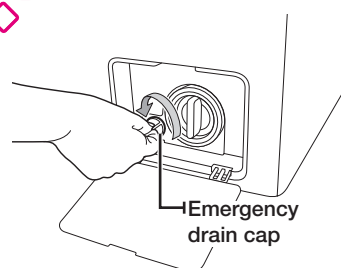

4. Hold the cap on the end of the emergency drain tube and slowly pull it out about 15 cm.
5. Allow all the water to flow into a bowl.
6. Reinsert the drain tube and screw the cap back on.
7. Replace the filter-cover.

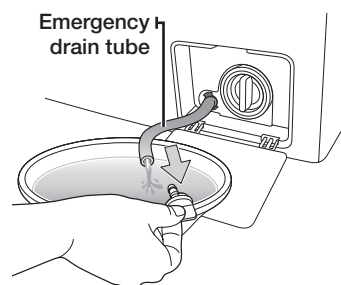

CLEANING THE EXTERIOR

1. Wipe the washing machine surfaces, including the control panel, with a soft cloth using a nonabrasive household detergent.
2. Use a soft cloth to dry the surfaces.
3. Do not pour water onto the washing machine.

CLEANING THE DETERGENT DRAWER AND DRAWER RECESS

1. Press the release lever on the inside of the detergent drawer and pull the drawer out.
2. Remove the liquid detergent divider from the detergent drawer

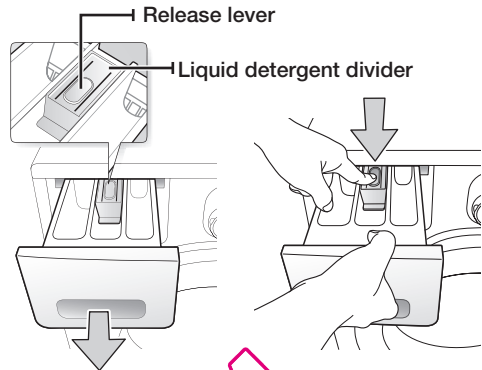

3. Wash all parts under running water.

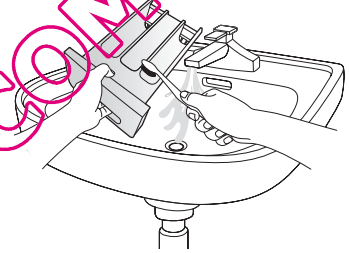

4. Clean the drawer recess with an old toothbrush.
5. Replace the liquid detergent divider by pushing it firmly into the drawer.
6. Push the drawer back into place.
7. To remove any remaining detergent, perform a rinse cycle without any laundry in the drum.

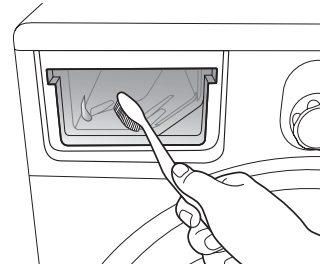

CLEANING THE DEBRIS FILTER

We recommend cleaning the debris filter 5 or 6 times a year, or when the error message of "5E" is displayed. (Refer to "Draining the washing machine in an emergency" in the previous page.)

1. Open the filter cover by using a key or coin.
2. Unscrew the emergency drain cap by turning it to the left and drain off all the water.
3. Unscrew the debris filter cap.

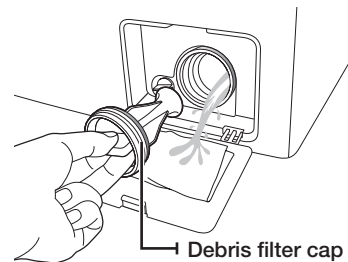

4. Wash any dirt or other material from the debris filter. Make sure the drain pump propeller behind the debris filter is not blocked.
5. Replace the debris filter cap.
6. Replace the filter cover.

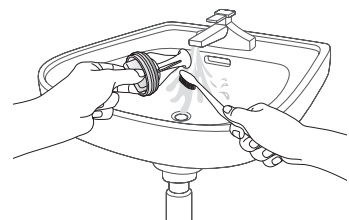

cleaning and maintaining your washing machine

CLEANING THE WATER HOSE MESH FILTER

You should clean the water hose mesh filter at least once a year, or when the error message of "4E" is displayed:

1. Turn off the water supply to the washing machine.
2. Unscrew the hose from the back of the washing machine. To prevent water from gushing out due to the air pressure in the hose, cover the hose with a cloth.
3. Gently pull out the mesh filter from the end of the hose using a pair of pliers and rinse it under water until clean. Also clean inside and outside the threaded connector.
4. Push the filter back into place.
5. Screw the hose back onto the washing machine.
6. Make sure the connections are watertight and turn on the tap.

REPAIRING A FROZEN WASHING MACHINE

If the temperature drops below freezing and your washing machine is frozen:

1. Unplug the washing machine.
2. Pour warm water over the tap to loosen the water supply hose.
3. Remove the water supply hose and soak it in warm water.
4. Pour warm water into the washing machine drum and let it sit for 10 minutes.
5. Reconnect the water supply hose to the water tap and check if the water supply and drain are operating normal.

STORING YOUR WASHING MACHINE

If you need to store your washing machine for an extended time, it's better to drain and disconnect it. Washing machines can be damaged if water is left in the hoses and internal components before storage.

1. Select the Quick 29' cycle and add bleach to the bleach compartment. Run your washing machine through the cycle without a load.
2. Turn the water taps off and disconnect the inlet hoses.
3. Unplug your washing machine from the electrical outlet, and leave your washing machine door open to allow air to circulate inside the tumbler.

 If your washing machine has been stored in below-freezing temperatures, allow time for any leftover water in your washing machine to thaw out before using it.

troubleshooting and information codes

CHECK THESE POINTS IF YOUR WASHING MACHINE...

PROBLEM	SOLUTION
Will not start	<ul style="list-style-type: none">• Make sure your washing machine is plugged in.• Make sure the door is firmly closed.• Make sure the water source tap(s) are turned on.• Make sure to press the Start/Pause button.
Has no water or not enough water	<ul style="list-style-type: none">• Turn the water tap on fully.• Make sure the water source hose is not frozen.• Straighten the water intake hoses.• Clean the filter on the water intake hose.
Has detergent remains in the detergent drawer after the wash cycle is complete	<ul style="list-style-type: none">• Make sure your washing machine is running with sufficient water pressure.• Make sure the detergent is added to the center of the detergent drawer.
Vibrates or is too noisy	<ul style="list-style-type: none">• Make sure your washing machine is on a level surface. If the surface is not level, adjust the washing machine feet to level the appliance.• Make sure that the shipping bolts are removed.• Make sure your washing machine is not touching any other object.• Make sure the laundry load is balanced.
The washing machine does not drain and/or spin	<ul style="list-style-type: none">• Straighten the drain hose. Eliminate kinked hoses.• Make sure the debris filter is not clogged.
Door is locked shut or will not open.	<ul style="list-style-type: none">• The door will not open until 3 minutes after the machine stops or the power turns off.

If the problem persists, contact your local Samsung Customer Service.

troubleshooting and information codes

INFORMATION CODES

When your washing machine malfunctions, you may see an information code on the display. If that happens, check this table and try the suggested solution before calling Customer Service.

CODE SYMBOL	SOLUTION
dE	<ul style="list-style-type: none">• Close the door.
4E	<ul style="list-style-type: none">• Make sure the source water tap is turned on.• Check the water pressure.
5E	<ul style="list-style-type: none">• Clean the debris filter.• Make sure the drainage hose is installed correctly.
UE	<ul style="list-style-type: none">• The laundry load is unbalanced. Redistribute the load. If only one item of clothing needs washing, such as a bathrobe or pair of jeans, the final spin result might be unsatisfactory and an "UE" error message will be shown in the display window.
cE/3E	<ul style="list-style-type: none">• Call the after-sales service.
Hot	<ul style="list-style-type: none">• It appears when the internal temperature of the drum is high. The fan will automatically function, so just wait until "Hot" indication disappeared.

For any codes not listed above, or if the suggested solution doesn't fix the problem, call your Samsung Service Centre or local Samsung dealer.

QUELLAVELINGE.COM

cycle chart

CYCLE CHART

(● user option)

PROGRAM	DETERGENT			Max Temp (°C)
	Pre-wash	wash	Softener	
Cotton	●	yes	●	95
Synthetics	●	yes	●	60
Denim	●	yes	●	60
Sports Wear	●	yes	●	60
Delicates	-	yes	-	40
Wool	-	yes	-	40
Handwash	-	yes	●	40
Deodorization	-	-	-	-
Sanitization	-	-	-	-
Drying	-	-	-	-
Daily Wash	●	yes	●	60
Quick 29'	-	yes	●	60

PROGRAM	Spin Speed(MAX) rpm			Delay end	Cycle time (min)
	WD8704	WD8702	WD8700		
Cotton	1400	1200	1000	●	120
Synthetics	1200	1200	1000	●	90
Denim	800	800	800	●	78
Sports Wear	1200	1200	1000	●	72
Delicates	800	800	800	●	50
Wool	800	800	800	●	38
Handwash	400	400	400	●	31
Deodorization	-	-	-	●	29
Sanitization	-	-	-	●	59
Drying	-	-	-	●	160
Daily Wash	1200	1200	1000	●	70
Quick 29'	1400	1200	1000	●	29





























1. A cycle with a prewash takes approx. 15 minutes longer.
2. The cycle duration data has been measured under the conditions specified in Standard IEC 60456 / EN 60456.
3. Course time in individual homes may differ from the values given in the table due to variations in the pressure and temperature of the water supply, the load and the type of laundry.
4. When the Intensive Wash function is selected, the cycle time is increased for each cycle.

appendix

FABRIC CARE CHART

The following symbols provide garment care directions. The care labels include four symbols in this order: washing, bleaching, drying and ironing, and dry cleaning when necessary.

The use of symbols ensures consistency among garment manufacturers of domestic and imported items. Follow the care label directions to maximize garment life and reduce laundering problems.

 Resistant material	 Can be ironed at 100 °C max
 Delicate fabric	 Do not iron
  Item may be washed at 95 °C	 Can be dry cleaned using any solvent
  Item may be washed at 60 °C	 Dry clean with perchloride, lighter fuel, pure alcohol or R113 only
  Item may be washed at 40 °C	 Dry clean with aviation fuel, pure alcohol or R113 only
  Item may be washed at 30 °C	 Do not dry clean
 Item may be hand washed	 Dry flat
 Dry clean only	 Can be hung to dry
 Can be bleached in cold water	 Dry on clothes hanger
 Do not bleach	 Tumble dry, normal heat
 Can be ironed at 200 °C max	 Tumble dry, reduced heat
 Can be ironed at 150 °C max	 Do not tumble dry

PROTECTING THE ENVIRONMENT

- This appliance is manufactured from recyclable materials. If you decide to dispose of this appliance, please observe local waste disposal regulations. Cut off the power cord so that the appliance cannot be connected to a power source. Remove the door so that animals and small children cannot get trapped inside the appliance.
- Do not exceed the detergent quantities recommended in the detergent manufacturers' instructions.
- Use stain removal products and bleaches before the wash cycle only when strictly necessary.
- Save water and electricity by only washing full loads (the exact amount depends upon the program used).

DECLARATION OF CONFORMITY

This appliance complies with European safety standards, EC directive 93/68 and EN Standard 60335.

SPECIFICATIONS

TYPE		FRONT LOADING WASHING MACHINE		
DIMENSIONS	WD8704CJ/WD8704DJ/WD8704EJ/WD8704RJ WD8702CJ/WD8702DJ/WD8702EJ/WD8702RJ WD8700CJ/WD8700DJ/WD8700EJ/WD8700RJ			
	W598mm X D600mm X H844mm			
WATER PRESSURE	50 kPa ~ 800 kPa			
WATER VOLUME	56 ℓ			
GROSS WEIGHT	WD8704CJ/ WD8704DJ/ WD8704EJ/ WD8704RJ	WD8702CJ/ WD8702DJ/ WD8702EJ/ WD8702RJ	WD8700CJ/ WD8700DJ/ WD8700EJ/ WD8700RJ	
	75 kg	74 kg	73 kg	
POWER CONSUMPTION	MODEL	WD8704CJ/WD8704DJ/WD8704EJ/WD8704RJ WD8702CJ/WD8702DJ/WD8702EJ/WD8702RJ WD8700CJ/WD8700DJ/WD8700EJ/WD8700RJ		
	WASHING	220 V	150 W	
		240 V	150 W	
	WASH AND HEATING	220 V	2000 W	
		240 V	2400 W	
	DRYING	230V	1600W	
	SPIN	MODEL	WD8704CJ/ WD8704DJ/ WD8704EJ/ WD8704RJ	WD8702CJ/ WD8702DJ/ WD8702EJ/ WD8702RJ
230V		350 W	250 W	200 W
PUMPING	34 W			
PACKAGE WEIGHT	MODEL	WD8704CJ/WD8704DJ/WD8704EJ/WD8704RJ WD8702CJ/WD8702DJ/WD8702EJ/WD8702RJ WD8700CJ/WD8700DJ/WD8700EJ/WD8700RJ		
	PAPER	2.5 kg		
	PLASTIC	2.5 kg		
SPIN REVOLUTIONS	MODEL	WD8704CJ/ WD8704DJ/ WD8704EJ/ WD8704RJ	WD8702CJ/ WD8702DJ/ WD8702EJ/ WD8702RJ	WD8700CJ/ WD8700DJ/ WD8700EJ/ WD8700RJ
	rpm	1400	1200	1000

The appearance and specifications of the product are subject to change without prior notice for purposes of product enhancement.

appendix

QUELLAVELINGE.COM

memo

QUELLAVELINGE.COM



QUELLAVELINGE.COM

QUESTIONS OR COMMENTS?

Country	CALL	OR VISIT US ONLINE AT
SOUTH AFRICA	0860-SAMSUNG(726-7864)	www.samsung.com/za

Code No. DC68-02748A_EN