

SAMSUNG

Washing Machine Owner's Instructions

Q1657A(V/T/S)

Q1457A(V/T/S)



Register your product at
www.samsung.com/global/register
Code No.: DC68-02150H-01_EN

QUELLAVELINGE.COM

Features

1. Energy Saving A+AA

We made the grade. Samsung's Q1657A(V/T/S), the latest in high-tech 1600rpm spin models, was awarded a triple A score: A+ rated for energy consumption, A rated for washing performance, and A rated for spin dry performance. As a result, you accumulate more free time and money to spend on what really-you and your family.

2. Silver Wash - Silver Nano Health System TM

Samsung's Silver Nano feature uses silver nano particles to sanitize and disinfect your laundry and your machine's drum. Delicates as well as smelly socks will get odor-free from human sweat at temperatures as low as 30°C.

That saves energy and protects color and form of your clothes.

3. Graphic Digital Display

The Graphic Digital Display control panel is clear and easy to use for minimum fuss and hassle. And whilst easy to operate, the Graphic Digital Display enables you to make quick and accurate adjustments to the wash for excellent washing results.

4. Shower Spinning

Leave the residue behind. With our Shower Spinning feature, jets of water are sprayed into the wash during the spin cycle. That ensures that detergent goes down the drain where it belongs.

5. Stop & Add - Pause Option

Forgot an item? No problem. Our Stop & Add function allows you to stop the washer, open the door and throw it in. A built-in sensor detects the water level and tells you when it's safe to open the door.

Safety Precautions

Congratulations on your purchase of this Samsung washing machine. These Owner's Instructions contain valuable information on the installation, use, and care of this appliance. Please take the time to read these instructions so that you can take full advantage of the washing machine's features and enjoy this appliance for many years to come.

Before using the appliance

- Packing materials can be dangerous to children; keep all packing material (plastic bags, polystyrene, etc.) well out of the reach of children.
- The appliance is designed for home use only.
- Make sure that water and electrical connections are made by qualified technicians, observing the manufacturer's instructions (see "Installing the Washing Machine") and local safety regulations.
- All packaging and shipping bolts must be removed before the appliance is used. Serious damage may occur if they are not removed. See "Removing the shipping bolts".
- Before washing clothes for the first time, you must run a complete cycle without clothes. See "Washing for the first time".

Safety instructions

- Before cleaning or carrying out maintenance, unplug the appliance from the electrical outlet.
- Make sure that the pockets of all clothing to be washed are empty. Hard, sharp objects, such as coins, safety pins, nails, screws, or stones can cause extensive damage to the appliance.
- Always unplug the appliance and turn off the water after use.
- Before you open the door of the appliance, check that the water has drained. Do not open the door if you can still see water.
- Never allow pets and children to play on or in the appliance. It may cause injury or suffocate them.
- The glass door becomes very hot during the washing cycle. Never touch on the glass door while it is in use.
- Do not attempt to repair the appliance yourself. Repairs made by inexperienced or unqualified persons may cause injury and/or make more serious repairs to the appliance necessary.
- If the plug (power supply cord) is damaged, it must be replaced by the manufacturer or its service agent or a similarly qualified person in order to avoid a hazard.
- This appliance should only be serviced by our authorized service center, and only rated spare parts should be used.
- This appliance is not intended for use by young children or infirm persons unless they have been adequately supervised by a responsible person to ensure that they can use the appliance safely. Young children should be supervised to ensure that they do not play with the appliance.
- To use this appliance safely, the user should become familiar with the instructions for operation of the appliance and always take extra care when using it.
- If the appliance needs an extension cord, make sure to keep it from water. Also, the extension cord shall be rated one and suitable for the appliance.
- This appliance should be positioned to be accessible to the power plug, the water supply tabs and the drain pipes.
- Do not use processed water containing oil, cream or lotion, which is usually found in skin-care shops or massage clinics.
 - Otherwise this will cause the packing to be deformed, which causes a malfunction or water leak.
- A stainless washing tube does not usually rust. However if some metal such as a hair pin is left in the tube for an extended time, the tube could rust.
 - Do not leave water or bleach containing chlorine in the tube for an extended period of time.
 - Do not regularly use or leave water containing iron in the tube for an extended period of time.If rust starts appearing on the surface of the tube, apply a cleansing agent (neutral) to the surface and use a sponge or soft cloth to clean it. (Under no circumstances use a metal brush)
- For washing machines with ventilation openings in the base, that a carpet must not obstruct the openings.
- Use the new hose-sets and old hose-sets should not be reused.

Table of Contents

Safety Precautions	inside cover
Installing the Washing Machine	2
Unpacking the washing machine	2
Overview of the washing machine	2
Selecting a location	3
Adjusting the leveling feet	3
Removing the shipping bolts	3
Connecting the water supply hose	4
Connecting the water supply hose (Option)	5
Positioning the drain hose	5
Plugging in the machine	6
Wiring Instructions	6
Washing a Load of Laundry	7
Washing for the first time	7
Putting detergent in the washing machine	7
Overview of the control panel	8
Washing clothes using Fuzzy Logic	10
Washing clothes manually	11
Using delay start	11
Washing tips and hints	12
Maintaining the Washing Machine	13
Draining the washing machine in an emergency	13
Repairing a frozen washing machine	13
Cleaning the exterior	13
Cleaning the detergent drawer and recess	14
Cleaning the debris filter	14
Cleaning the water hose mesh filter	15
Troubleshooting	16
Problems and solutions	16
Understanding error messages	16
Caution: When using the Duvet course	17
Programme Chart	18
Appendix	20
Fabric care chart	20
Electrical warnings	20
Protecting the environment	21
Declaration of conformity	21
Specification	21



This marking shown on the product or its literature, indicates that it should not be disposed with other household wastes at the end of its working life. To prevent possible harm to the environment or human health from uncontrolled waste disposal, please separate this from other types of wastes and recycle it responsibly to promote the sustainable reuse of material resources.

Household users should contact either the retailer who purchased this product, or their local government office, for details of where and how they can take this item for environmentally safe recycling. Business users should contact their supplier and check the terms and conditions of the purchase contract. This product should not be mixed with other commercial wastes for disposal.

Installing the Washing Machine

Unpacking the washing machine

Unpack your washing machine and inspect it for shipping damage. Also make sure that you have received all of the items shown below. If the washing machine was damaged during shipping or you do not have all of the items, contact your Samsung dealer immediately.

Overview of the washing machine

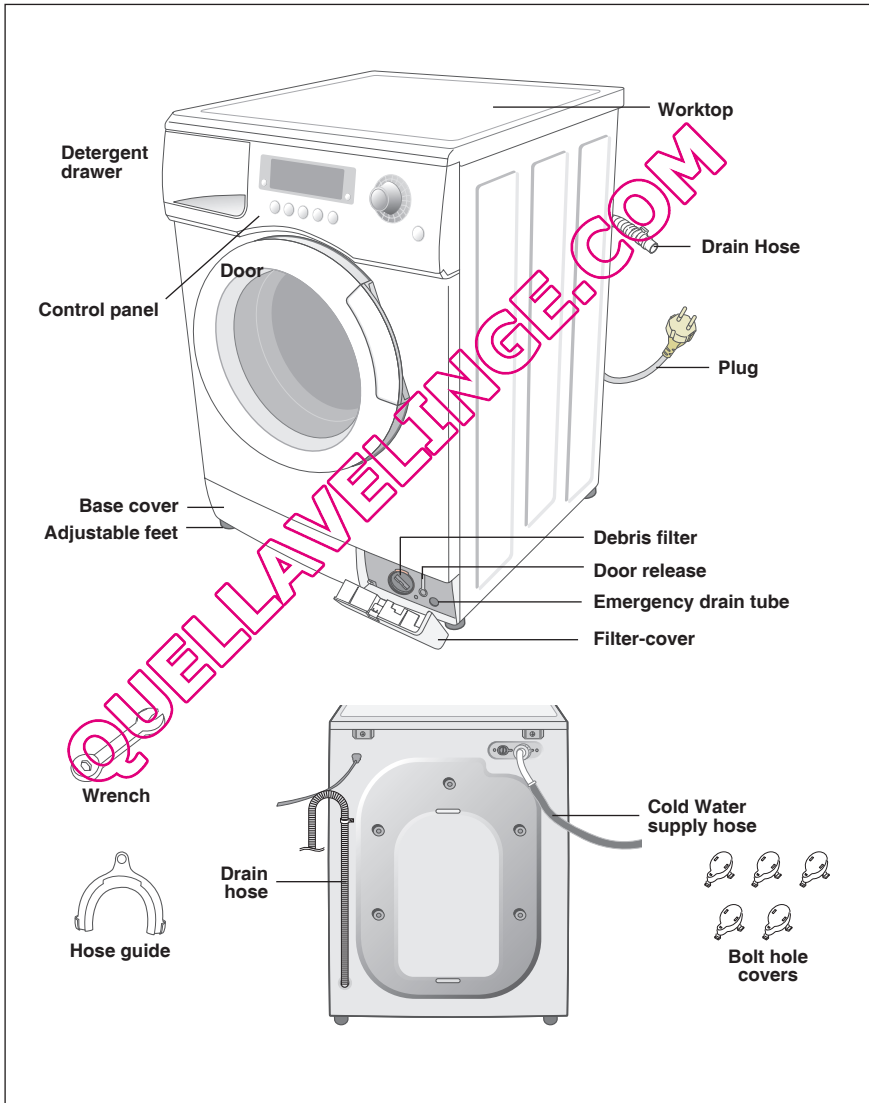

Installing the Washing Machine

Selecting a location

Before you install the washing machine, select a location with the following characteristics:

- A hard, level surface (if the surface is uneven, see "Adjusting the leveling feet," below)
- Away from direct sunlight.
- Adequate ventilation
- Room temperature that will not fall below 0 °C
- Away from sources of heat such as coal or gas

Make sure that the washing machine does not stand on its power cord.

Ventilation openings must not be obstructed by carpeting when the washing machine is installed on a carpeted floor.

Adjusting the leveling feet

If the floor is uneven, adjust the feet (do not insert pieces of wood or any other objects under the feet):

1. Loosen the leg bolt by turning it with your hand until it is at the desired height.
2. Tighten the locking nut by turning it with the supplied wrench.

If the washer is placed on an uneven or weak surface, noise or vibration occurs. (Only 1 degree angle is allowed.)

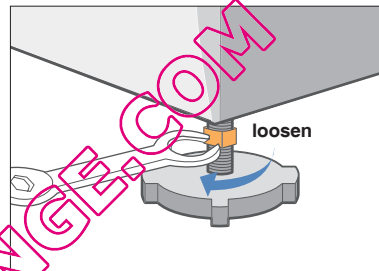

Removing the shipping bolts

Before using the washing machine, you must remove the five shipping bolts from the back of the unit. To remove the bolts:

1. Loosen all bolts with the supplied wrench before removing them.
2. Take each bolt head and pull it through the wide part of the hole. Repeat for each bolt.
3. Fill the holes with the supplied plastic covers.
4. Keep the shipping bolts for future use.

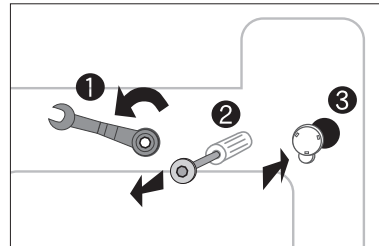

Installing the Washing Machine

Connecting the water supply hose

The water supply hose must be connected to the washing machine at one end and to the water faucet at the other. Do not stretch the water supply hose. If the hose is too short replace the hose with a longer, high pressure hose.

To connect the water supply hose:

1. Take the L-shaped arm fitting for the cold water supply hose and connect to the cold water supply intake on the back of the machine. Tighten by hand.
2. Connect the other end of the cold water supply hose to your sink's cold water faucet and tighten it by hand. If necessary, you can reposition the water supply hose at the washing machine end by loosening the fitting, rotating the hose, and retightening the fitting.

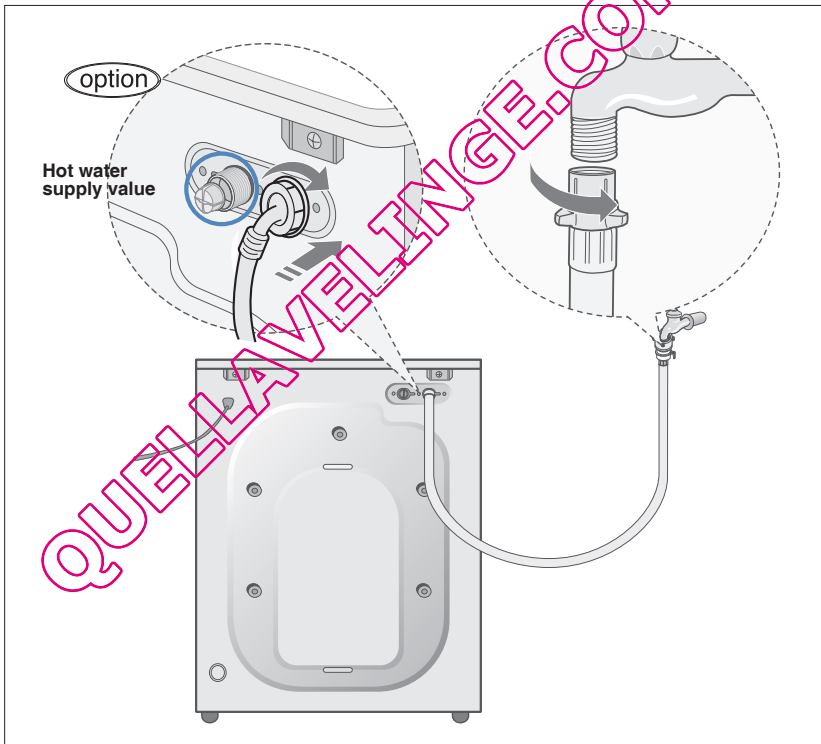

NOTICE The appliance is to be connected to the water mains using new hose-sets and that old hose-sets should not be used.



- Option:
1. Take the red L-shaped arm fitting for the hot water supply hose and connect to the red hot water supply intake on the back of the machine. Tighten by hand.
 2. Connect the other end of the hot water supply hose to your sink's hot water faucet and tighten it by hand.
 3. Use a Y-piece if you only want to use cold water.

Installing the Washing Machine

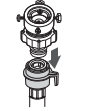
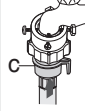
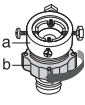
Connecting the water supply hose (Option)

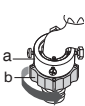
1. Remove the adaptor from the water supply hose.			4. Connect the water supply hose to the adaptor. Pull down part (c) of the water supply hose. When you release part (c) the hose automatically connects to the adaptor making a 'click' sound.
2. First, using a '+' type screw driver, loosen the four screws on the adaptor. Next, take the adaptor and turn part(b) following the arrow until there is a 5mm gap.			5. Connect the other end of the water supply hose to the inlet water valve at the rear of the washer. Screw the hose clockwise all the way in
3. Connect adaptor to the water tap by tightening the screws firmly. Then, turn part (b) following the arrow and put(a) and (b) together.			

NOTICE After completing connection, if water leaks from the hose, then repeat the same steps. Use the most conventional type of faucet for water supply. In case the faucet is square or too big, remove the spacing ring before inserting the faucet into the adaptor.

Positioning the drain hose

The end of the drain hose may be positioned in three ways.

Over the edge of a wash basin

The drain hose must be placed at a height of between 60 and 90 cm. To keep the drain hose spout bent, use the supplied plastic hose guide. Secure the guide to the wall with a hook or to the faucet with a piece of string to prevent the drain hose from moving.

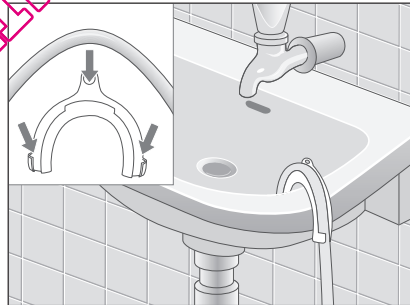

In a sink drain pipe branch

The drain pipe branch must be above the sink siphon so that the end of the hose is at least 60 cm above the ground.

In a drain pipe

Samsung recommends that you use a 65 cm high vertical pipe; it must be no shorter than 60 cm and no longer than 90 cm.

Installing the Washing Machine

Plugging in the machine

For European Users. You will NOT need to ground the plug of the washing machine.

For U.S. Users. You MUST ground the plug of the washing machine.

Check with a licensed electrician before using the machine to make sure it is properly grounded.

For U.K. Users.

Wiring Instructions

WARNING THIS APPLIANCE MUST BE EARTHED.

This appliance must be earthed. In the event of an electrical short circuit, earthing reduces the risk of electric shock providing an escape wire for the electric current.

The appliance is equipped with a mains lead which includes an earth wire for connecting to the earth terminal of your mains plug.

The plug must be plugged into a socket that is properly installed and earthed.

- * The wires in this mains lead are coloured in accordance with the following code:
 - Green and yellow : Earth
 - Blue : Neutral
 - Brown : Live
- AS the colours of the wires in the mains lead of this appliance may not correspond with the coloured markings indentifying the terminals in your plug, proceed as follows.
- Connect the green and yellow wire to the terminal in the plug marked with the letter E or the earth symbol (\perp) or coloured green or green-and-yellow.
- Connect the blue wire to the terminal marked with the letter N or coloured black.
- Connect the brown wire to the terminal marked with the letter L or coloured red.
- * Consult a qualified electrician or service technician if in doubt about any of these instructions. The manufacturer of this washing machine will not accept any liability for damage to persons or material for non observance of these requirements. There are no user serviceable parts inside the washing machine and if the mains lead of this appliance is damaged, it must only be replaced by qualified service personnel approved by the manufacturer because special tools are required.

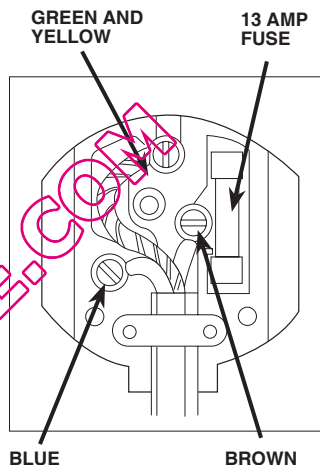

WARNING

Ensure that the plug and power cord are not damaged before use. If you have any reason to remove the moulded plug from this appliance, immediately remove the fuse and dispose of the plug. Do not connect the plug to a mains socket under any circumstances as there is a danger of electric shock.



CIRCUITS

Your washing machine should be operated on a separate circuit from other appliances. Failure to do this may cause the circuit breaker to trip or the fuse to blow.

Washing a Load of Laundry

Washing for the first time

Before washing clothes for the first time, you must run a complete cycle without clothes. To do this:

1. Press the  (On/Off) button.
2. Pour a little detergent into compartment  in the detergent drawer.
3. Turn on the water supply to the washing machine.
4. Press the Temperature button repeatedly until 40 °C is displayed.
5. Press the Start/Pause button.
 - This will remove any water from the manufacturer's test run remaining in the machine.

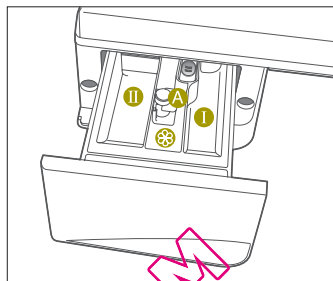



Dispenser  : Detergent for prewash or starch.

Dispenser  : Detergent for main wash, water softener, pre-soaking agent, bleach and stain removal product.

Dispenser  : Additives, e.g. fabric softener or former (fill no higher than lower edge of insert "A")

Putting detergent in the washing machine

1. Pull out the detergent drawer.
2. Add laundry detergent into compartment .
3. Add softener into compartment  (if you desire).
4. Add prewash detergent into compartment  (if you desire).

Caution :

Concentrated or thick fabric softener and conditioner must be diluted with a little water before being poured into the dispenser (prevents the overflow from becoming blocked.)

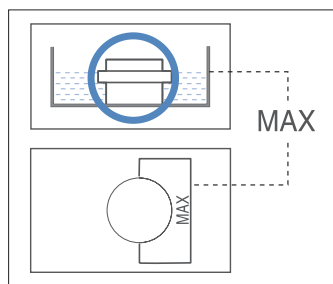

Washing a Load of Laundry

Overview of the control panel

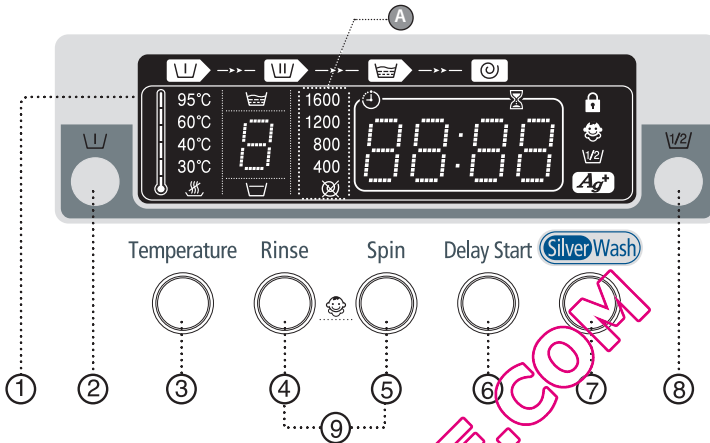

× This is a general manual. The INLAY system may be different from that of the product you purchased. For **A**, see item 5 below to select the right specifications that match your product.

1. Digital graphic display

Displays the remaining wash cycle time, all of washing information and error messages.

2. Prewash selection button

Press the button to select pre-wash. Pre-wash is available only with Curtain, Towel, Bedding, Duvet, Cotton, Coloureds, Synthetics, Delicates.

3. Temperature selection button

Press the button repeatedly to cycle through the available water temperature options (cold water (❄️), 30 °C, 40 °C, 60 °C and 95 °C).

4. Rinse selection button

Press the rinse button to add rinse cycles. Maximum number of rinse cycles is five.

5. Spin selection button

Press the button repeatedly to cycle through the available spin speed options.

Q1657A	❄️, ❄️, 400, 800, 1200, 1600 rpm	❄️ : no spin,
Q1457A	❄️, ❄️, 400, 800, 1200, 1400 rpm	❄️ : rinse hold

No spin

The laundry remains in the drum without being spun after the final drain

Rinse Hold

The laundry remains soaking in the final rinse water.

Before the laundry can be unloaded, either "Drain" or the "Spin" program must be run.

Washing a Load of Laundry

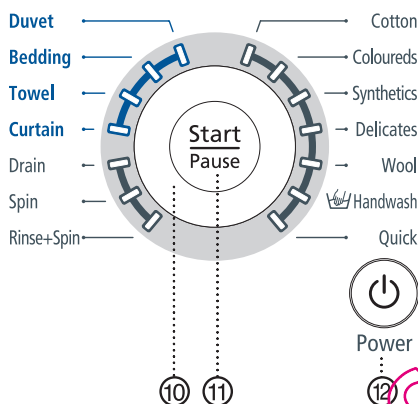

6. Delay Start selection button

Press the button repeatedly to cycle through the available delayed start options (from 3 hour to 24 hours in one hour increments).
Displayed hours means the time of finished washing-cycle.

7. Silver Wash selection button

Silver Nano water is supplied in washing as well as the last rinse, featuring sterilization and antibacterial coating.

8. Economy selection button

Press the button in case of Economy (about 1~4kg) washing. This function saves washing time and energy.

9. Child Lock selection button

Press the Rinse and Spin button simultaneously for 2~3 seconds to prevent mis-operation by a child. When the "Child Lock" is on, other buttons can not be selected.
To cancel the "Child Lock", press the Rinse and Spin button simultaneously for 2~3 seconds.

10. Fuzzy Control dial

Turn the dial to select one of the 14 available wash programs.

Cotton, Coloureds, Synthetics, Delicates, Wool, Hand wash, Quick, Rinse+Spin, Spin, Drain, Curtain, Towel, Bedding, Duvet

11. Start/Pause selection button

Press to pause and restart programs.

12. (On/Off) selection button

Press once to turn the washing machine on, press again to turn the washing machine off. If the washing machine power is left on for longer than 10 minutes without any buttons being touched, the power automatically turns off.

Washing a Load of Laundry

Washing clothes using Fuzzy Logic

Your new washing machine makes washing clothes easy, using Samsung's "Fuzzy Logic" automatic control system. When you select a wash program, the machine will set the correct temperature, washing time, and washing speed.

To wash clothes using the Fuzzy Logic programs:

1. Turn on your sink's water faucet.
2. Press the (On/Off) button.
3. Open the door.
4. Load the articles one at a time loosely into the drum, without overfilling.
5. Close the door.
6. Add the detergent, softener, and pre-wash detergent (if necessary) into the appropriate compartment.

Note: Pre-wash is only available when washing Duvet, Bedding, Towel, Curtain, Cotton, Coloureds, Synthetics and Delicates programs. It is only necessary if your clothing is heavily soiled.

7. Turn the Fuzzy Control dial to select the appropriate program for the type of clothes Cotton, Coloureds, Synthetics, Delicates, Wool, Handwash, Quick, Duvet, Bedding, Towel, Curtain. You will see the indicators light up on the control panel.
8. At this time, you can control the wash temperature, rinsing times, spin speed, delay time by pressing the appropriate option button.
9. Press the Start/Pause button on the Fuzzy Control dial and the wash cycle will begin. The process indicator will light up and the remaining time for the cycle will appear in the display.

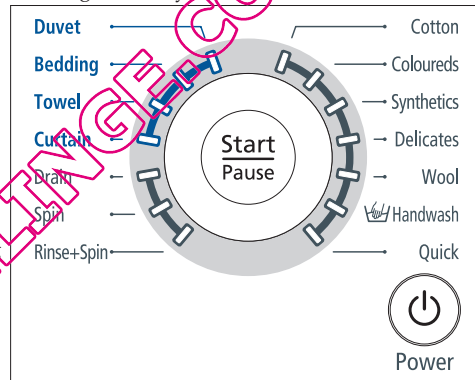

Pause Option

1. Within 5 minutes of starting a wash, it is possible to add/remove laundry items to the load.
2. By depressing the START/PAUSE button, the door is unlocked.
3. The door can NOT be opened when the water is too HOT or the water level is too HIGH.
4. After closing the door, depressing the START/PAUSE button again will restart the washing process.

When the cycle is finished:

After the total cycle has finished, the power will turn off automatically.

1. Open the door.
2. Remove laundry.

Washing a Load of Laundry

Washing clothes manually

You can wash clothes manually without using the Fuzzy Logic feature. To do so:

1. Turn the water supply on.
2. Press the \odot (On/Off) button on the washing machine.
3. Open the door.
4. Load the articles one at a time loosely into the drum, without overfilling.
5. Close the door.
6. Put the detergent and, if necessary, softener or prewash detergent, in the appropriate compartments.
7. Press the Temperature button to select the temperature (cold water, 30°C, 40°C, 60°C, 95°C)
8. Press the rinse button to select the required number of rinse cycles. Maximum number of rinse cycles is five. The washing duration will be prolonged accordingly.
9. Press the Spin button to select the spin speed.

Note: The rinse hold program allows you to take clothes that are dripping wet out of the washing machine.

\otimes : No Spin, \sphericalangle : Rinse Hold

10. Press the button repeatedly to cycle through the available delayed start options (from 3 hour to 24 hours in one hour increments). Displayed hours means the time of finished washing-cycle.
11. Press the Start/Pause button and the machine will begin the cycle.

Using delay start

You can set the washing machine to finish your wash automatically at a later time, choosing from 3 to 24 hour delay (in 1 hour increments). Displayed hours means the time of finished washing-cycle.

To do this:

1. Manually or automatically set your washing machine for the type of clothes you are washing.
2. Press the Delay Start button repeatedly until the delay time is set.
3. Press the Start/Pause button. The Delay Start indicator will light, and the clock will begin counting down until it reaches your finish time.
4. To cancel Delay Start, press the \odot (On/Off) button, then turn the washing machine on again.

Washing a Load of Laundry

Washing tips and hints

Sorting your laundry: Sort your laundry according to the following characteristics:

- **Type of fabric care label symbol:** Sort laundry into cottons, mixed fibers, synthetics, silks, wools and rayon.
- **Colour:** Divide whites and colours. Wash new, coloured items separately.
- **Size:** Placing items of different sizes in the same load will improve the washing action.
- **Sensitivity:** Wash delicate items separately, using the Delicate wash program for pure new wool, curtains and silk articles. Check the labels on the items you are washing or refer to the fabric care chart in the appendix.

Emptying pockets: Coins, safety pins and similar items can damage linen, the washing machine drum, and the water tank.

Securing fasteners: Close zippers and fasten buttons or hooks; loose belts or ribbons should be tied together.

Prewashing cotton: Your new washing machine, combined with modern detergents, will give perfect washing results, thus saving energy, time, water and detergent. However, if your cotton is particularly dirty, use a prewash with a protein-based detergent.

Determining load capacity: Do not overload the washing machine or your laundry may not wash properly. Use the chart below to determine the load capacity for the type of laundry you are washing.

Fabric Type	Load Capacity
Cotton / Coloured	7.5 kg
Synthetics / Towel	4.0 kg
Quick	3.0 kg
Delicates	2.5 kg
Wools / Handwash	2.0 kg
Curtain / Bedding	5.0 kg
Duvet	1 king size (9 Tog)

- When the laundry is unbalanced ("UE" lights up on the display), redistribute the load.

Detergent tips: The type of detergent you should use is based on the type of fabric (cotton, synthetic, delicate items, wool), colour, wash temperature, degree and type of soiling. Always use "low suds" laundry soap, which is designed for automatic washing machines.

Follow the detergent manufacturer's recommendations based upon the weight of the laundry, the degree of soiling, and the hardness of the water in your area. If you do not know how hard your water is, ask your water authority.

Note: Keep detergents and additives in a safe, dry place out of the reach of children.

Maintaining the Washing Machine

Draining the washing machine in an emergency

1. Unplug the washing machine from the power supply.
2. Open the filter-cover by using a coin or a key.

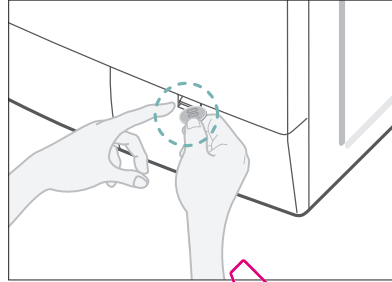

3. Unscrew the emergency drain cap by turning left. Grip the cap on the end of the emergency drain tube and slowly pull it out about 15 cm.
4. Allow all the water to flow into a bowl.
5. Reinsert the drain tube and screw the cap back on.
6. Replace the filter-cover.

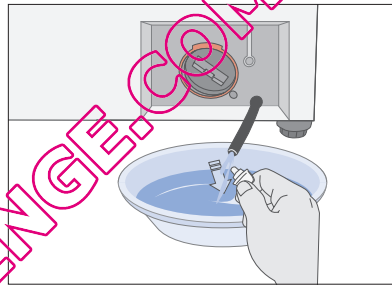

Repairing a frozen washing machine

If the temperature drops below freezing and your washing machine is frozen:

1. Unplug the washing machine.
2. Pour warm water on the source faucet to loosen the water supply hose.
3. Remove the water supply hose and soak it in warm water.
4. Pour warm water into the washing machine drum and let it sit for 10 minutes.
5. Reconnect the water supply hose to the water faucet and check if the water supply and drain operations are normal.

Cleaning the exterior

1. Wipe the washing machine surfaces, including the control panel, with a soft cloth and non-abrasive household detergents.
2. Use a soft cloth to dry the surfaces.
3. Do not pour water on the washing machine.

Maintaining the Washing Machine

Cleaning the detergent drawer and recess

1. Press the release lever on the inside of the detergent drawer and pull it out. (as shown below)
2. Remove the cap from compartment ⑥.
3. Wash all of the parts under running water.
4. Clean the drawer recess with an old toothbrush.
5. Reinsert the cap (Pushing it firmly into place) and replace the liquid detergent divider into the drawer.
6. Push the drawer back into place.
7. Run a rinse program without any laundry in the drum.

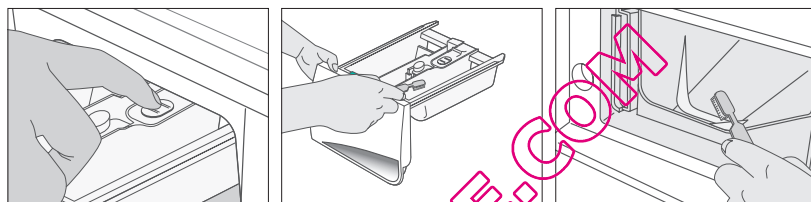

Cleaning the debris filter

Clean the debris filter 5 or 6 times a year, or when you see the following error message on the display:

5E

1. Open the filter-cover, See "Draining the washing machine in an emergency" on page 13.
2. Unscrew emergency drain cap by turning left and drain off all the water. See "Draining the washing machine in an emergency" on page 13.
3. Unscrew the filter cap and take it out.

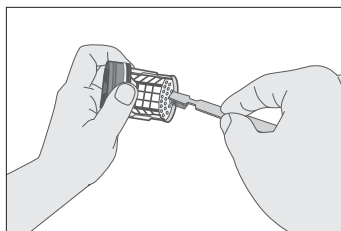

4. Wash any dirt or other material from the filter. Make sure the drain pump propeller behind the filter is not blocked. Replace the filter cap.
5. Replace the filter-cover.

Maintaining the Washing Machine

Cleaning the water hose mesh filter

You should clean the water hose mesh filter at least once a year, or when you see the following error message on the display:

4E

To do this:

1. Turn off the water source to the washing machine.
2. Unscrew the hose from the back of the washing machine.
3. With a pair of pliers, gently pull out the mesh filter from the end of the hose and rinse it under water until clean. Also clean the inside and outside of the threaded connector.

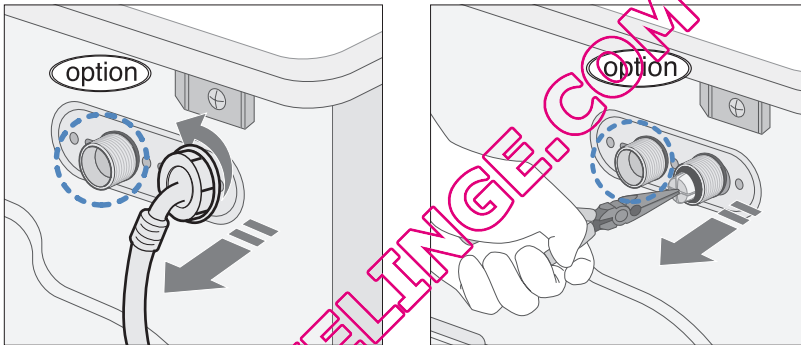

4. Push the filter back into place.
5. Screw the hose back onto the washing machine.
6. Turn on the faucet and make sure the connections are watertight.

Troubleshooting

Problems and solutions

The washing machine will not start

- Make sure the washing machine is plugged in.
- Make sure the door is firmly closed.
- Make sure the water source faucet is turned on.
- Make sure to press the Start/Pause button.

No water or insufficient water supply

- Make sure the water source faucet is turned on.
- Make sure the water source hose is not frozen.
- Make sure the water intake hose is not bent.
- Make sure the filter on the water intake hose is not clogged.

Detergent remains in the detergent drawer after the wash program is complete

- Make sure the washing machine is running with sufficient water pressure.
- Put the detergents in the inner parts of the detergent drawer (away from the outside edges).

Washing machine vibrates or is too noisy

- Make sure the washing machine is set on a level surface. If the surface is not level, adjust the washing machine feet to level the appliance.
- Make sure that the shipping bolts are removed.
- Make sure the washing machine is not touching any other object.
- Make sure the laundry load is balanced.

The washing machine does not drain and/or spin



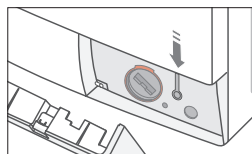



- Make sure the drain hose is not squashed or bent.
- Make sure the debris filter is not clogged.



The Door does not open

1. Disconnect the power plug from the power supply.
2. Remove the water from the washing machine.
3. Open the filter cover using a coin.
4. Locate the orange plastic tab and pull forward to open the door.

Understanding error messages

Error displayed	Solution
	<ul style="list-style-type: none"> • Close the door.
	<ul style="list-style-type: none"> • Make sure the source water faucet is turned on. • Check the water pressure.
	<ul style="list-style-type: none"> • Clean the debris filter. • Make sure the drainage hose is installed correctly.
	<ul style="list-style-type: none"> • Laundry load is unbalanced. Redistribute the load. If only one item of clothing needs washing, such as a bathrobe or jeans, the final spin result might be unsatisfactory and an "UE" error message will be shown in the display window.
 	<ul style="list-style-type: none"> • Call after-sales service.

Before contacting After-Sales service:

1. Try to remedy the problem (See "Troubleshooting" on this page).
2. Restart the programme to see if the fault is repeated.
3. If the malfunction persists, call after-sales service and describe the problem.

Troubleshooting

Caution: When using the Duvet course

Use of Detergents in Duvet Course

When washing larger volume laundry items, including duvet, do not put the following detergents directly into the drum:

- . Tablet and capsule type detergents



- . Detergents using ball and net.

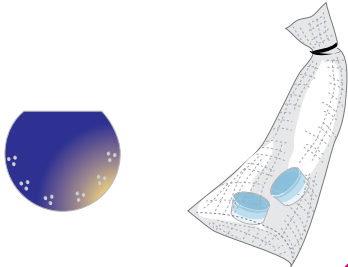

Detergents not fully dissolved may bring about imperfect washing. For effective washing, add detergent into the detergent drawer.

Do not wash a duvet by spreading detergent directly on it.

Cautions in Putting Duvet in the Drum

1. Do not use unnecessary force or too large Duvet.
2. Make sure that a corner or folded part of the duvet directs inwards.

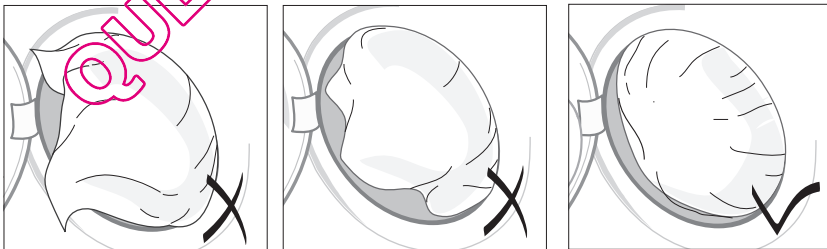

Picture of Duvet being put in properly

Programme Chart

(* user option)

PROGRAM	Max load (kg)	DETERGENT AND ADDITIVES			Tem (°C)		Spin Speed (MAX) rpm		Delay start	Economy	Water (l)	Electricity (kWh)
		Prewash	wash	Softener	default	Max	Q1657A	Q1457A				
Cotton	7.5	*	yes	*	60	95	1600	1400	*	*	55	1.27
Coloureds	7.5	*	yes	*	40	60	1600	1400	*	*	70	0.80
Synthetics	4.0	*	yes	*	40	60	800	800	*	*	65	0.60
Delicates	2.5	*	yes	*	40	40	800	800	*	*	60	0.50
Wool	2.0	-	yes	*	30	40	400	400	*	*	60	0.30
Handwash	2.0	-	yes	*	30	40	400	400	*	*	60	0.30
Quick	3.0	-	yes	*	30	60	1200	1200	*	-	45	0.30

Program	Type of WASH
Cotton	Averagely or lightly soiled cottons, bed linen, table linen, underwear, towels, shirts, etc.
Coloureds	Averagely or lightly soiled cottons, bed linen, table linen, underwear, towels, shirts, etc.
Synthetics	Averagely or lightly soiled blouses, shirts, etc., which are made of polyester (diolen, trevira), polyamide (perlon, nylon) or other similar blends.
Delicates	Delicate curtains, dresses, skirts, shirts and blouses.
Wool	Only machine washable woolens with pure new wool label.
Handwash	Very light wash course like hand wash.
Quick	Slightly soiled cottons or linen blouses, shirts, dark coloured terry cloth, coloured linen articles, jeans, etc.

1. Programme with prewash lasts approx. 15 minutes longer.
2. The programme duration data has been measured under the conditions specified in Standard IEC 456.
3. Consumption in individual homes may differ from the values given in the table due to variations in the pressure and temperature of the water supply, the load and the type of laundry.

Programme Chart





























(* user option)

PROGRAM	Max load (kg)	DETERGENT AND ADDITIVES			Tem (°C)		Spin Speed (MAX) rpm		Delay start	Economy	Water (l)	Electricity (kWh)
		Prewash	wash	Softener	default	Max	Q1657A	Q1457A				
Duvet	1 king size (9 Tog)	*	yes	*	40	60	800	800	*	*	60	0.50
Bedding	5.0	*	yes	*	60	95	1600	1400	*	*	70	1.35
Towel	4.0	*	yes	*	60	95	1600	1400	*	*	85	1.50
Curtain	5.0	*	yes	*	40	60	1200	1200	*	*	85	0.65

Program	Type of WASH
Duvet	Cotton bedding with filling, duvet, pillow, blanket, sofa cover with light filling.
Bedding	Cotton bedding, bed linen, bed sheet, duvet cover, pillow cover etc.
Towel	Pile weave cotton towels, bath towel, bath gown.
Curtain	Cotton or mixed cotton thick curtain, tow-face curtain(face, lining), lightly soiled furniture linen, sofa cover without filling etc.

Appendix

Fabric care chart

	Resistant material		Can be ironed at 100 °C max
	Delicate fabric		Do not iron
			Can be dry cleaned using any solvent
			Dry clean with perchloride, lighter fuel, pure alcohol or R113 only
			Dry clean with aviation fuel, pure alcohol or R113 only
			Do not dry clean
	Item may be hand washed		Dry flat
	Dry clean only		Can be hung to dry
	Can be bleached in cold water		Dry on clothes hanger
	Do not bleach		Tumble dry, normal heat
	Can be ironed at 200 °C max		Tumble dry, reduced heat
	Can be ironed at 150 °C max		Do not tumble dry

Electrical warnings

To reduce the risk of fire, electrical shock, and other injuries, keep these safety precautions in mind:

- Operate the appliance only from the type of power source indicated on the marking label. If you are not sure of the type of power supplied to your home, consult your appliance dealer or local power company.
- Use only a grounded or polarized outlet. For your safety, this appliance is equipped with a polarized alternating current line plug having one blade wider than the other. This plug will fit into the power outlet only one way. If you are unable to insert the plug fully into the outlet, try reversing the plug. If the plug still doesn't fit, contact your electrician to replace your outlet.
- Protect the power cord. Power supply cords should be routed so that they are unlikely to be walked on or pinched by items placed on or against them. Pay particular attention to cords at plugs, convenience receptacles, and the point where they exit from the unit.
- Do not overload the wall outlet or extension cords. Overloading can result in fire or electric shock.

Protecting the environment

- This appliance is manufactured from recyclable materials. If you decide to dispose of this appliance, please observe local waste disposal regulations. Cut off the power cord so that the appliance cannot be connected to a power source. Remove the door so that animals and small children cannot get trapped inside the appliance.
- Do not exceed the detergent quantities recommended in the detergent manufacturers' instructions.
- Use stain removal products and bleaches before the wash cycle only when strictly necessary.
- Save water and electricity by only washing full loads (the exact amount depends upon the program used).

Declaration of conformity

This appliance complies with European safety standards, EC directive 93/68 and EN Standard 60335.

Specification

TYPE	FRONT LOADING WASHER			
DIMENSION	W600mm × D600mm × H850mm			
WATER PRESSUERE	50 kPa ~ 200 kPa			
WEIGHT	75kg			
WASH and SPIN CAPACITY	7.5kg (DRY LAUNDRY)			
POWER CONSUMPTION	WASHING	220V	150W	
		240V	150W	
	WASHING AND HEATING	220V	2400W	
		240V	2800W	
	SPIN	MODEL	Q1657A	Q1457A
		230V	700W	500W
	PUMPING	34W		
WATER VOLUME	55 l (STANDARD COURSE)			
SPIN REVOLUTION	MODEL	Q1657A	Q1457A	
	rpm	1600	1400	
PACKAGE Wt	PAPER	2.5kg		
	PLASTIC	1.0kg		

The appearance and specifications of the product are subject to change without prior notice for purposes of enhancement.

Memo

QUELLAVELINGE.COM

QUELLAVELINGE.COM



Contact SAMSUNG WORLD WIDE
If you have any questions or comments relating to Samsung products, please contact the SAMSUNG customer care center.
Samsung Electronics U.K. Ltd. Unit C, Stafford Park 12 Telford, Shropshire TF3 3BJ The United Kingdom
0870 242 0303
www.samsung.com/uk

QUELLAVELINGE.COM

